

Panasonic®

Operating Instructions 26"/32" DIAGONAL LCD TV Manual de instrucciones TV DE LCD DE 26"/32" DIAGONAL

Model No. **TC-26LE70**
Número de modelo **TC-32LE70**



Quick Start Guide

(See page 6)

Guía de inicio rápido

(vea la página 6)



- For assistance (U.S.A.), please call:
1-800-211-PANA (7262)
or visit us at www.panasonic.com/contactinfo
- For assistance (Puerto Rico), please call:
787-750-4300
or visit us at www.panasonic.com
- For assistance (Canada), please call:
1-800-561-5505
or visit us at www.panasonic.ca
- Para solicitar ayuda (EE.UU.), llame al:
1-800-211-PANA (7262)
ó visítenos en www.panasonic.com/contactinfo
- Para solicitar ayuda (Puerto Rico), llame al:
787-750-4300
ó visítenos en www.panasonic.com

HDMI™
HIGH-DEFINITION MULTIMEDIA INTERFACE

HDTV

English

Please read these instructions before operating your set and retain them for future reference.
The images shown in this manual are for illustrative purposes only.

Español

Lea estas instrucciones antes de utilizar su televisor y guárdelas para consultarlas en el futuro.
Las imágenes mostradas en este manual tienen solamente fines ilustrativos.

TQB2AA0831

Turn your own living room into a movie theater!
Experience an amazing level of multimedia excitement



HDMI™
HIGH-DEFINITION MULTIMEDIA INTERFACE

HDMI, the HDMI logo and High-Definition Multimedia Interface are trademarks or registered trademarks of HDMI Licensing LLC.

HDAVI Control™

HDAVI Control™ is a trademark of Matsushita Electric Industrial Co., Ltd.

EZ Sync™

EZ Sync™ is a trademark of Matsushita Electric Industrial Co., Ltd.

Enjoy rich multimedia

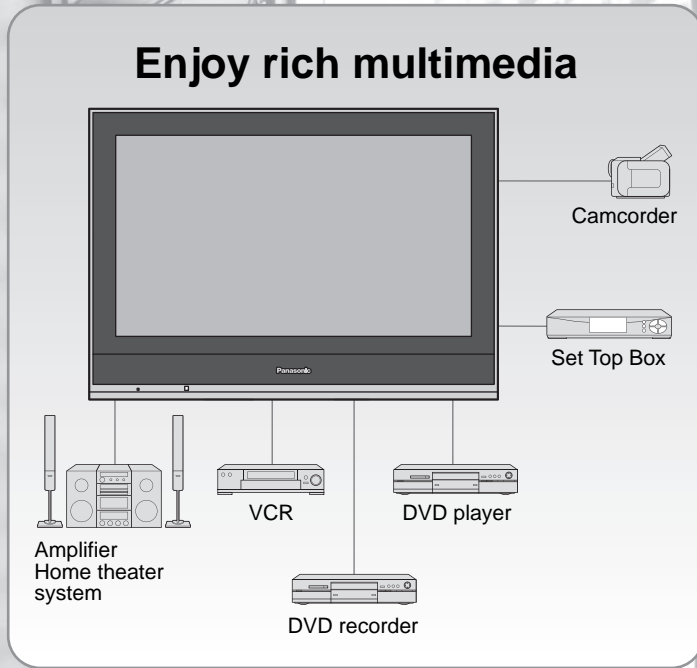

Contents

Please read before using the unit

- Safety Precautions 4

Quick Start Guide

- Accessories/Optional Accessory ... 6
- Before Connection 8
- Basic Connection 9
- Identifying Controls 15
- First Time Setup 16

Enjoy your TV!

Basic Features

- Watching TV 18
- Watching Videos and DVDs 20

Advanced Features

- How to Use Menu Functions (picture, sound quality, etc.) 22
- EZ Sync™ “HDAVI Control™” 26
- Lock 28
- Editing and Setting Channels 30
- Input Labels/Monitor out/Closed Caption 32
- Using Timer 34
- Recommended AV Connections 36

FAQs, etc.

- Ratings List for Lock 38
- Technical Information 39
- Maintenance 41
- FAQ 42
- Specifications 44
- Limited Warranty (for U.S.A.) 45
- Customer Services Directory (for U. S. A.) 46
- Limited Warranty (for Canada) 47

HDTV



Manufactured under license from Dolby Laboratories. DOLBY and the double-D symbol are trademarks of Dolby Laboratories.

Safety Precautions

	CAUTION RISK OF ELECTRIC SHOCK DO NOT OPEN	
WARNING: To reduce the risk of electric shock, do not remove cover or back. No user-serviceable parts inside. Refer servicing to qualified service personnel.		

 The lightning flash with arrow head within a triangle is intended to tell the user that parts inside the product are a risk of electric shock to persons.

 The exclamation point within a triangle is intended to tell the user that important operating and servicing instructions are in the papers with the appliance.

Note to CATV System Installer

This reminder is provided to direct the CATV system installer's attention to Article 820-40 of the NEC that provides guidelines for proper grounding and, in particular, specifies that the cable ground shall be connected to the grounding system of the building, as close to the point of cable entry as practical.

Secure Ventilation

Slots and openings in the cabinet and the back or bottom are provided for ventilation, and to ensure reliable operation of the LCD TV and to protect it from overheating. These openings must not be blocked or covered. There should be at least 10 cm of space from these openings. The openings should never be blocked by placing the LCD TV on a bed, sofa, rug or other similar surface. This LCD TV should not be placed in a built-in installation such as a bookcase unless proper ventilation is provided.

Important Safety Instructions

- 1) Read these instructions.
- 2) Keep these instructions.
- 3) Heed all warnings.
- 4) Follow all instructions.
- 5) Do not use this apparatus near water.
- 6) Clean only with dry cloth.
- 7) Do not block any ventilation openings. Install in accordance with the manufacturer's instructions.
- 8) Do not install near any heat sources such as radiators, heat registers, stoves, or other apparatus (including amplifiers) that produce heat.
- 9) Do not defeat the safety purpose of the polarized or grounding-type plug. A polarized plug has two blades with one wider than the other. A grounding type plug has two blades and a third grounding prong. The wide blade or the third prong are provided for your safety. If the provided plug does not fit into your outlet, consult an electrician for replacement of the obsolete outlet.
- 10) Protect the power cord from being walked on or pinched particularly at plugs, convenience receptacles, and the point where they exit from the apparatus.
- 11) Only use attachments / accessories specified by the manufacturer.
- 12) Use only with the cart, stand, tripod, bracket, or table specified by the manufacturer, or sold with the apparatus. When a cart is used, use caution when moving the cart / apparatus combination to avoid injury from tip-over.
- 13) Unplug this apparatus during lightning storms or when unused for long periods of time.
- 14) Refer all servicing to qualified service personnel. Servicing is required when the apparatus has been damaged in any way, such as power-supply cord or plug is damaged, liquid has been spilled or objects have fallen into the apparatus, the apparatus has been exposed to rain or moisture, does not operate normally, or has been dropped.
- 15) Operate only from the type of power source indicated on the marking label. If you are not sure of the type of power supplied to your home consult your television dealer or local power company.
- 16) Follow all warnings and instructions marked on the LCD TV.
- 17) Never push objects of any kind into this LCD TV through cabinet slots as they may touch dangerous voltage points or short out parts that could result in a fire or electric shock. Never spill liquid of any kind on the LCD TV.
- 18) If an outside antenna is connected to the television equipment, be sure the antenna system is grounded so as to provide some protection against voltage surges and built up static charges. In the U.S. Section 810-21 of the National Electrical Code provides information with respect to proper grounding of the mast and supporting structure, grounding of the lead-in wire to an antenna discharge unit, size of grounding conductors, location of antenna discharge unit, connection to grounding electrodes, and requirements for the grounding electrode.

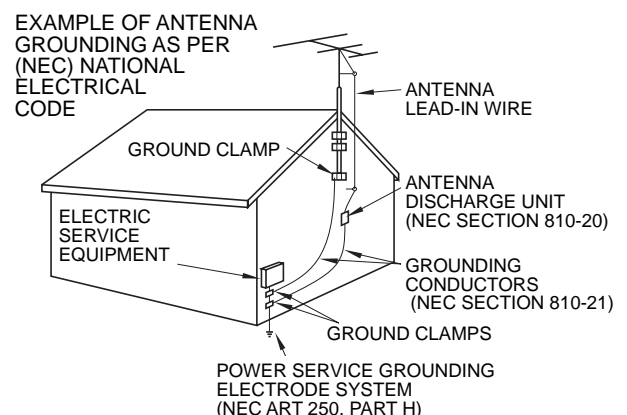

- 19) An outside antenna system should not be located in the vicinity of overhead power lines, other electric light, power circuits, or where it can fall into such power lines or circuits. When installing an outside antenna system, extreme care should be taken to keep from touching such power lines or circuits as contact with them might be fatal.
- 20) Unplug this LCD TV from the wall outlet and refer servicing to qualified service personnel under the following conditions:
- When the power cord or plug is damaged or frayed.
 - If liquid has been spilled into the LCD TV.
 - If the LCD TV has been exposed to rain or water.
 - If the LCD TV does not operate normally by following the operating instructions.

Adjust only those controls that are covered by the operating instructions as improper adjustment of other controls may result in damage and will often require extensive work by a qualified technician to restore the LCD TV to normal operation.
 - If the LCD TV has been dropped or the cabinet has been damaged.
 - When the LCD TV exhibits a distinct change in performance - this indicates a need for service.
- 21) When replacement parts are required, be sure the service technician uses replacement parts specified by the manufacturer that have the same characteristics as the original parts. Unauthorized substitutions may result in fire, electric shock, or other hazards.
- 22) **WARNING: TO REDUCE THE RISK OF FIRE OR ELECTRIC SHOCK, DO NOT EXPOSE THIS APPARATUS TO RAIN, MOISTURE, DRIPPING OR SPLASHING. DO NOT PLACE LIQUID CONTAINERS (FLOWER VASES, CUPS, COSMETICS, ETC.) ABOVE THE SET (INCLUDING ON SHELVES ABOVE, ETC.).**
- 23) **WARNING: SMALL PARTS CAN PRESENT CHOKING HAZARD IF ACCIDENTALLY SWALLOWED. KEEP SMALL PARTS AWAY FROM YOUNG CHILDREN. DISCARD UNNEEDED SMALL PARTS AND OTHER OBJECTS, INCLUDING PACKAGING MATERIALS AND PLASTIC BAGS/SHEETS TO PREVENT THEM FROM BEING PLAYED WITH BY YOUNG CHILDREN, CREATING THE POTENTIAL RISK OF SUFFOCATION.**
- 24) **CAUTION: TO PREVENT ELECTRIC SHOCK, DO NOT USE THIS PLUG WITH A RECEPTACLE OR OTHER OUTLET UNLESS THE BLADES CAN BE FULLY INSERTED TO PREVENT BLADE EXPOSURE.**
- 25) **CAUTION: USE WITH OTHER STAND MAY RESULT IN INSTABILITY POSSIBLY CAUSING INJURY.**
- 26) **CAUTION: DANGER OF EXPLOSION IF BATTERY IS INCORRECTLY REPLACED. REPLACE ONLY WITH THE SAME OR EQUIVALENT TYPE.**
- 27) **CAUTION: This LCD TV is for use only with the following optional accessory. Use with any other type of optional accessories may cause instability which could result in the possibility of injury.**
 (All of the following accessories are manufactured by Matsushita Electric Industrial Co., Ltd.)
- Wall-hanging bracket (Vertical): TY-WK32LR2W
- Always be sure to ask a qualified technician to carry out set-up.

NOTE: This equipment is designed to operate in North America and other countries where the broadcasting system and AC house current are exactly the same as in North America.

■ **This product utilizes tin-lead solder and has a fluorescent lamp containing a small amount of mercury. Disposal of these materials may be regulated in your community due to environmental considerations. For disposal or recycling information, please contact your local authorities or the Electronics Industries Alliance: www.eiae.org.**

FCC STATEMENT

This equipment has been tested and found to comply with the limits for a TV Broadcast Receiver, pursuant to Part 15 of the FCC Rules. These limits are designed to provide reasonable protection against harmful interference in a residential installation. This equipment generates, uses and can radiate radio frequency energy and, if not installed and used in accordance with the instructions, may cause harmful interference to radio communications. However, there is no guarantee that interference will not occur in a particular installation. If this equipment does cause or receive interference, which can be determined by turning equipment off and on, the user is encouraged to try to correct the interference by one or more of the following measures:

Reorient or relocate the TV antenna.
 Increase the separation between TV and other equipment.
 Connect TV into separate outlet from other equipment.
 Consult the dealer or an experienced radio / TV technician for help.

FCC Caution: Any changes or modifications not expressly approved by the party responsible for compliance could void the user's authority to operate this equipment.

Accessories/Optional Accessory

Check you have all the items shown.

Accessories

- Remote Control Transmitter
- N2QAYB000103



- Batteries for the Remote Control Transmitter (2)
- AA Battery

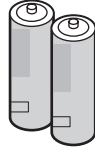

- HDMI Cable

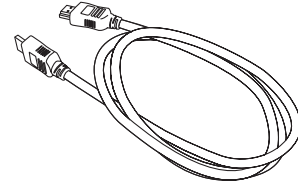

- Product Registration Card (U.S.A.)

- Customer Care Plan Card (U.S.A.)

- Operating Instructions
- Notice sheet (Demo mode)
- Warranty Card (Mexico)
- Quick Setup Guide (For viewing HD programming)

Installing remote's batteries

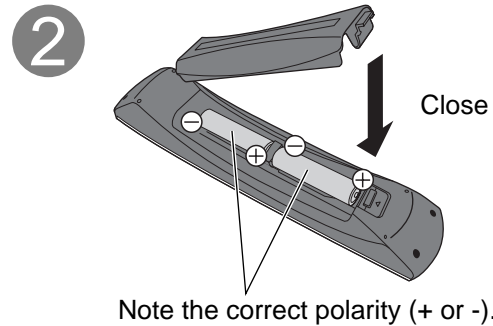
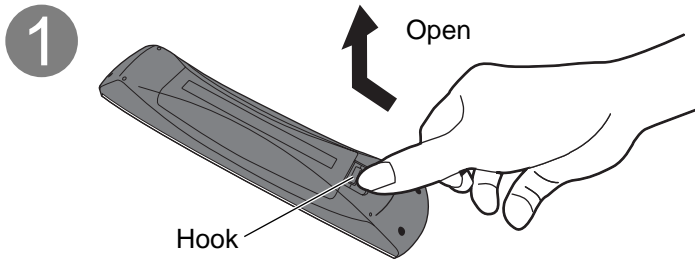

Caution

- Incorrect installation may cause battery leakage and corrosion, resulting in damage to the remote control unit.
 - Do not mix old and new batteries.
 - Do not mix different battery types (such as alkaline and manganese batteries).
 - Do not use rechargeable (Ni-Cd) batteries.
- Do not burn or break batteries.

Location

Place the TV at a comfortable distance for viewing. Avoid placing it where sunlight or other bright light (including reflections) will fall on the screen.
Use of some types of fluorescent lighting can reduce remote control transmitter range.
Adequate ventilation is essential to prevent an internal component failure. Keep away from areas of excessive heat or moisture.

Optional accessory (When installing on the wall)

Please contact your nearest Panasonic dealer to purchase the recommended wall-hanging bracket. For additional details, please refer to the wall-hanging bracket installation manual.

Wall-hanging bracket (vertical)
● TY-WK32LR2W

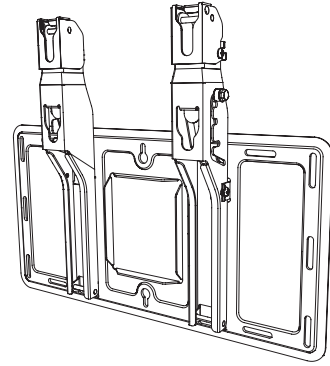

Before mounting the TV on the wall, you must remove the TV-Stand from the TV.
Follow the steps below:

1 Disconnect all the cables from the TV.

2 Remove the TV-Stand.

Ⓐ Remove four screws

Ⓑ Pull out the TV-Stand

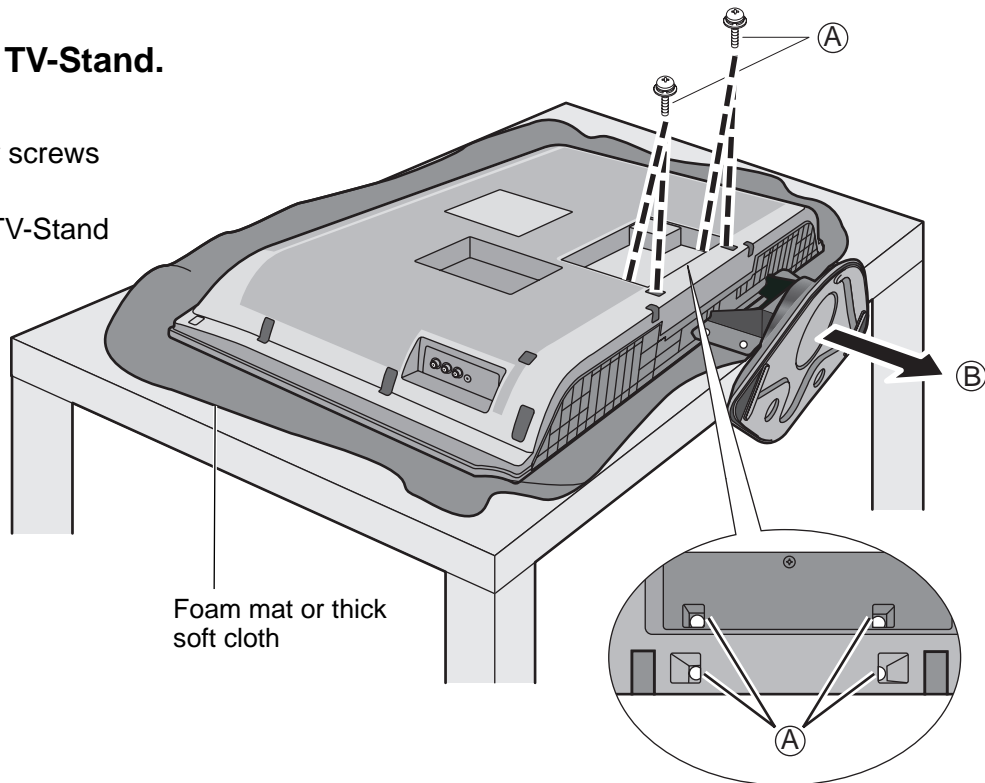

WARNING

- Failure to use a Panasonic bracket or choosing to mount the unit yourself will be done at the risk of the consumer. Any damage resulting from not having a professional installer mount will void your unit's warranty.
- Always be sure to ask a qualified technician to carry out set-up. Incorrect fitting may cause equipment to fall, resulting in injury and product damage.
- Do not mount this LCD Television directly below ceiling lights (such as spotlights, floodlights, or halogen lights) which typically give off high heat. Doing so may warp or damage plastic cabinet parts.

Before Connection

Connected Equipment Introduction (Signal source)

■ Watching TV

- VHF/UHF Antenna
 - NTSC (National Television System Committee):
Conventional broadcasting
 - ATSC (Advanced Television Systems Committee):
Digital TV Standards include digital high-definition television (HDTV), standard-definition television (SDTV), data broadcasting, multi-channel surround-sound audio and interactive television.
- Cable Box/Cable
 - You need to subscribe to a cable TV service to enjoy viewing their programming.
 - You can enjoy high-definition programming by subscribing to a high-definition cable box. The connection can be done with the use of HDMI or Component Video cable.

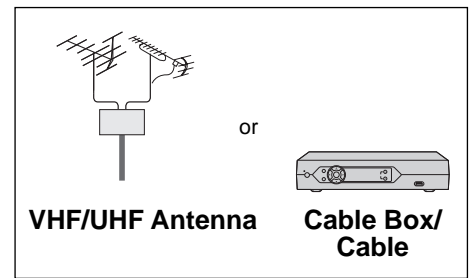

■ Recording/playing back with DVD recorder or VCR

- DVD Recorder
This source has higher resolution through interlace or progressive signal. Connection can be done with the use of Component Video or HDMI cable.
- VCR
Connection can be done with the use of an RF cable and Composite Video/S Video cable.

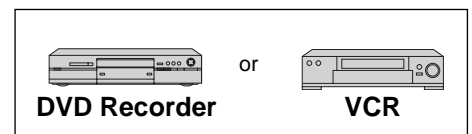

■ Watching Satellite

- You can enjoy high-definition programming by subscribing to high-definition satellite source. Connection can be done with the use of HDMI or Component Video cable.

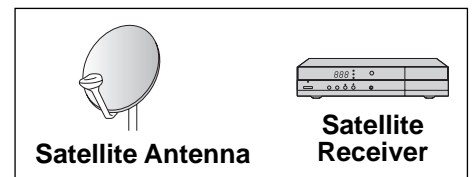

■ Enjoying Home theater and DVD recorder with HDMI connection

- Home theater and DVD Recorder
HDMI connection enables you to enjoy higher quality audio and video with a single cable.

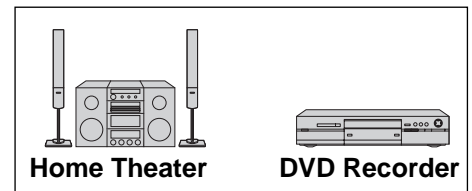

Note

- If your Panasonic DVD Recorder is compatible with EZ Sync (HDAVI control 2), you can operate your Panasonic DVD Recorder with this TV's remote control (p. 21 EZ Sync™).
- All cables and external equipment shown in this book are not supplied with the TV.
- For the details of the external equipment's connections, please refer to the operating manuals of the equipment.

Reference of connection

■ Antenna terminal

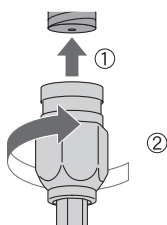

- Firmly tighten by hand.

■ Pin terminals

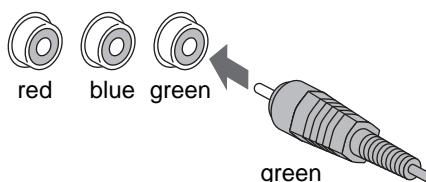

- Match colors of plugs and terminals.
- Insert firmly.

■ HDMI terminal

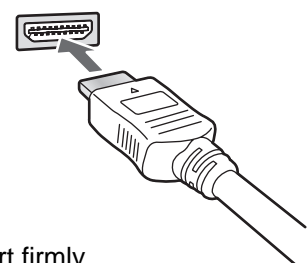

- Insert firmly.

Basic Connection

Example 1

Connecting Antenna (To watch TV)

TV

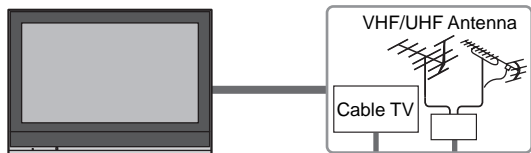

To connect antenna terminals

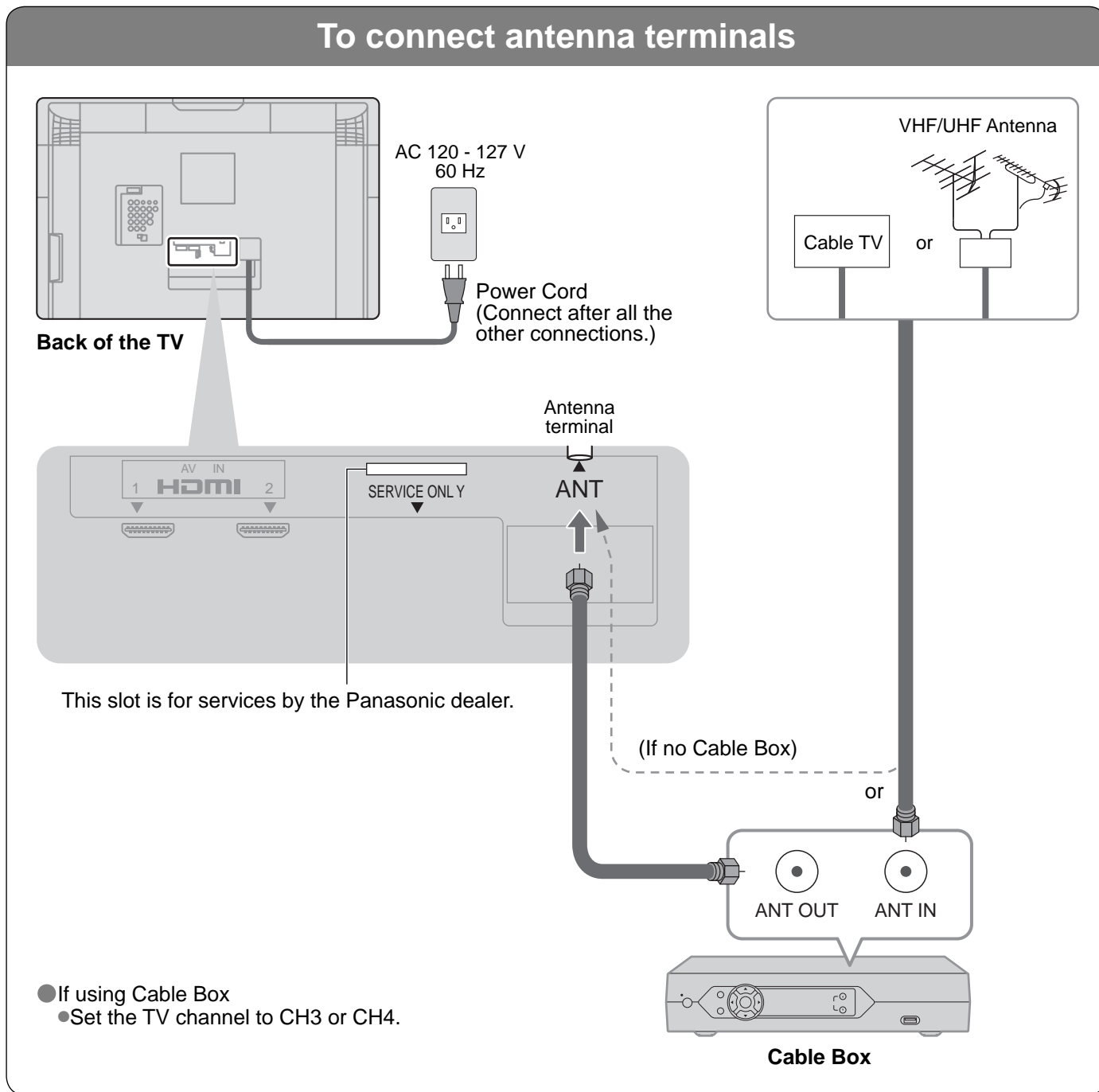

Note

- For additional assistance, visit us at: www.panasonic.com
www.panasonic.ca

Basic Connection (Continued)

Example 2 Connecting DVD recorder (VCR) (To record/playback)

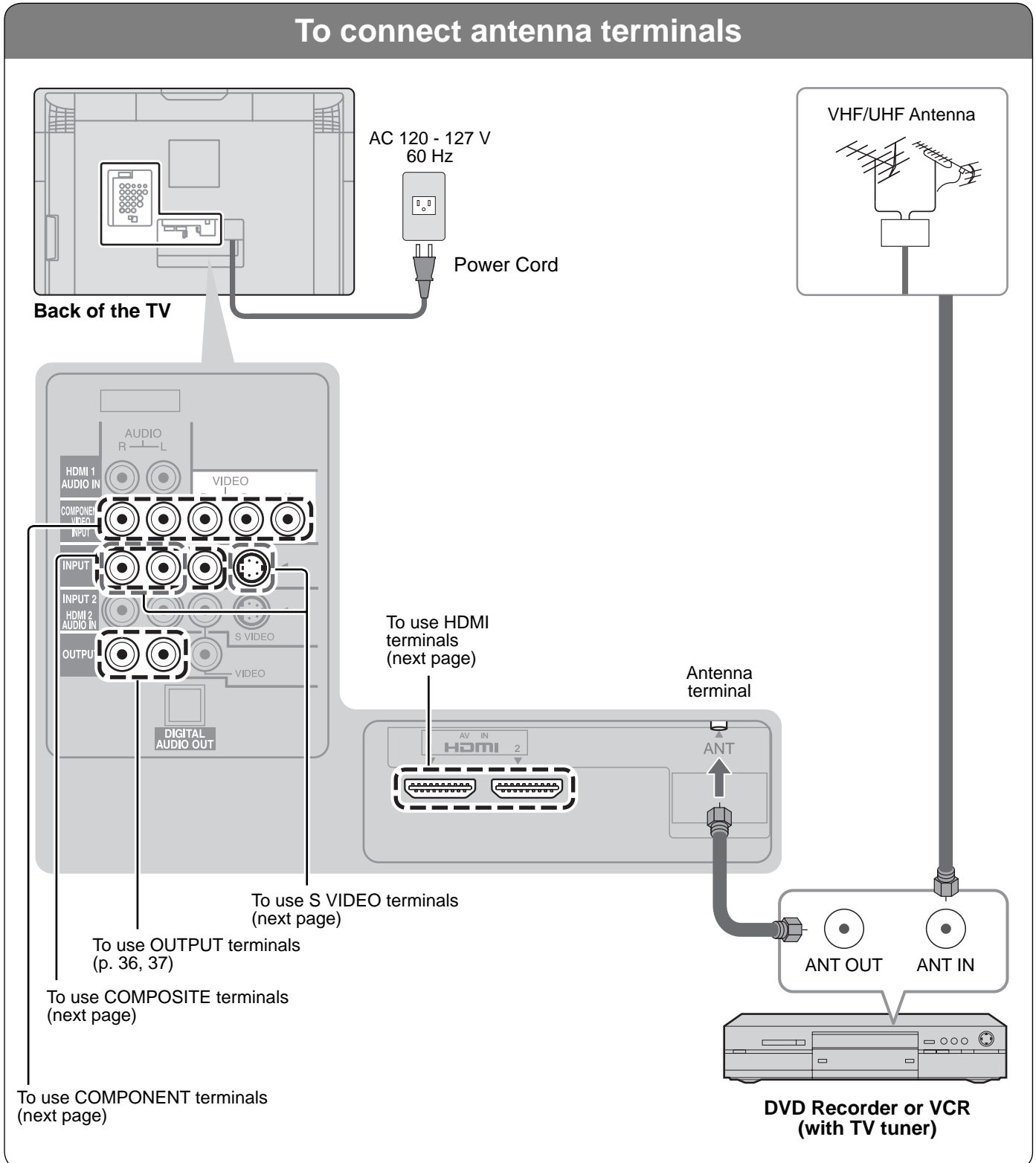

High-Definition

■ To use HDMI terminals

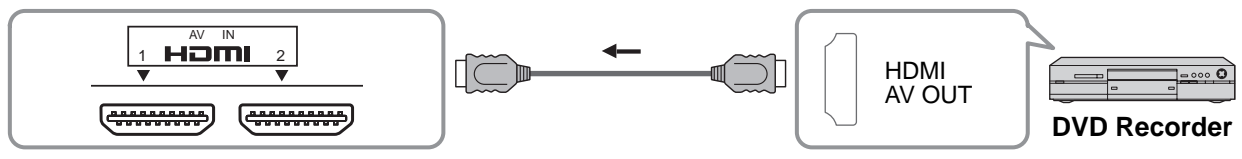

● Connecting to HDMI terminals will enable you to enjoy high-definition digital images and high-quality sound.

■ To use COMPONENT terminals

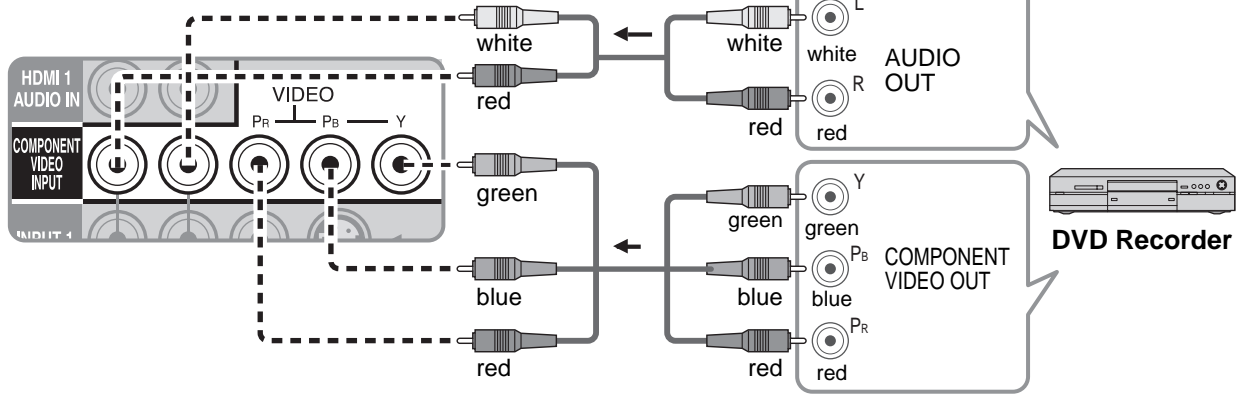

● Recorders may also be connected to COMPOSITE or S VIDEO terminals. (see below)

Standard-Definition

■ To use COMPOSITE terminals

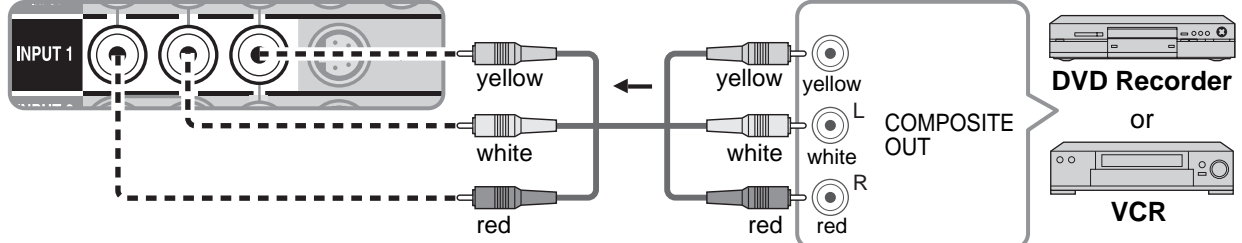

■ To use S VIDEO terminals

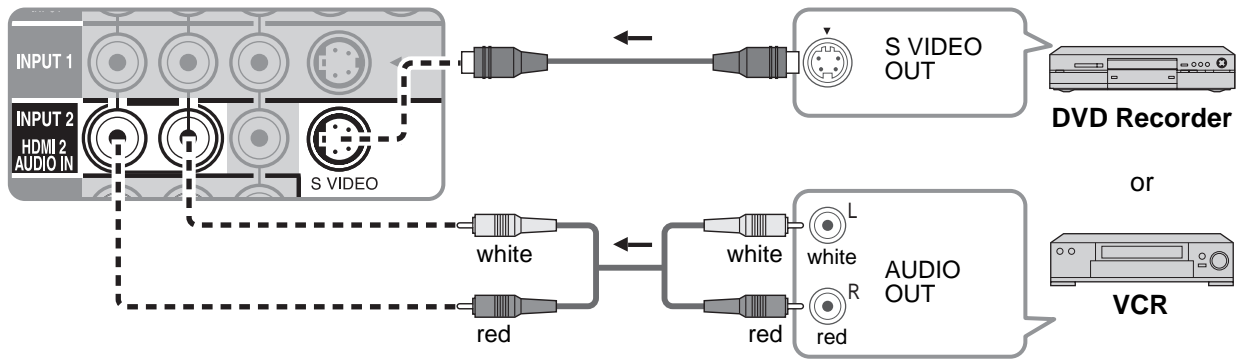

● The S Video input will override the composite video signal when S Video cable is connected. Connect either S Video or Video cable.

● Connecting to S VIDEO terminals will enable you to enjoy greater picture quality than using Composite terminals.

Note

- Some programs contain a copyright protection signal to prevent recording.
- When the copyright protection program is displayed, do not connect the other TV monitor through a VCR. Video signals fed through VCRs may be affected by copyright protection systems and the picture will be distorted on the other TV monitor.

Basic Connection (Continued)

Example 3 Connecting DVD recorder (VCR) and satellite receiver

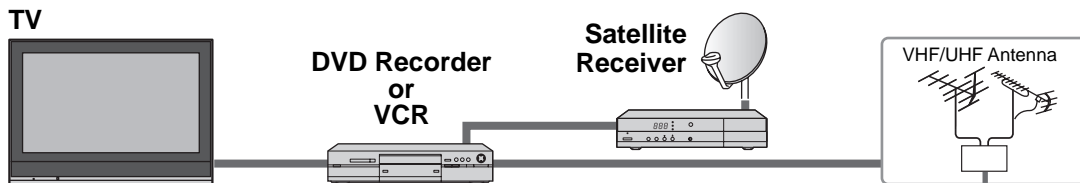

To connect antenna terminals

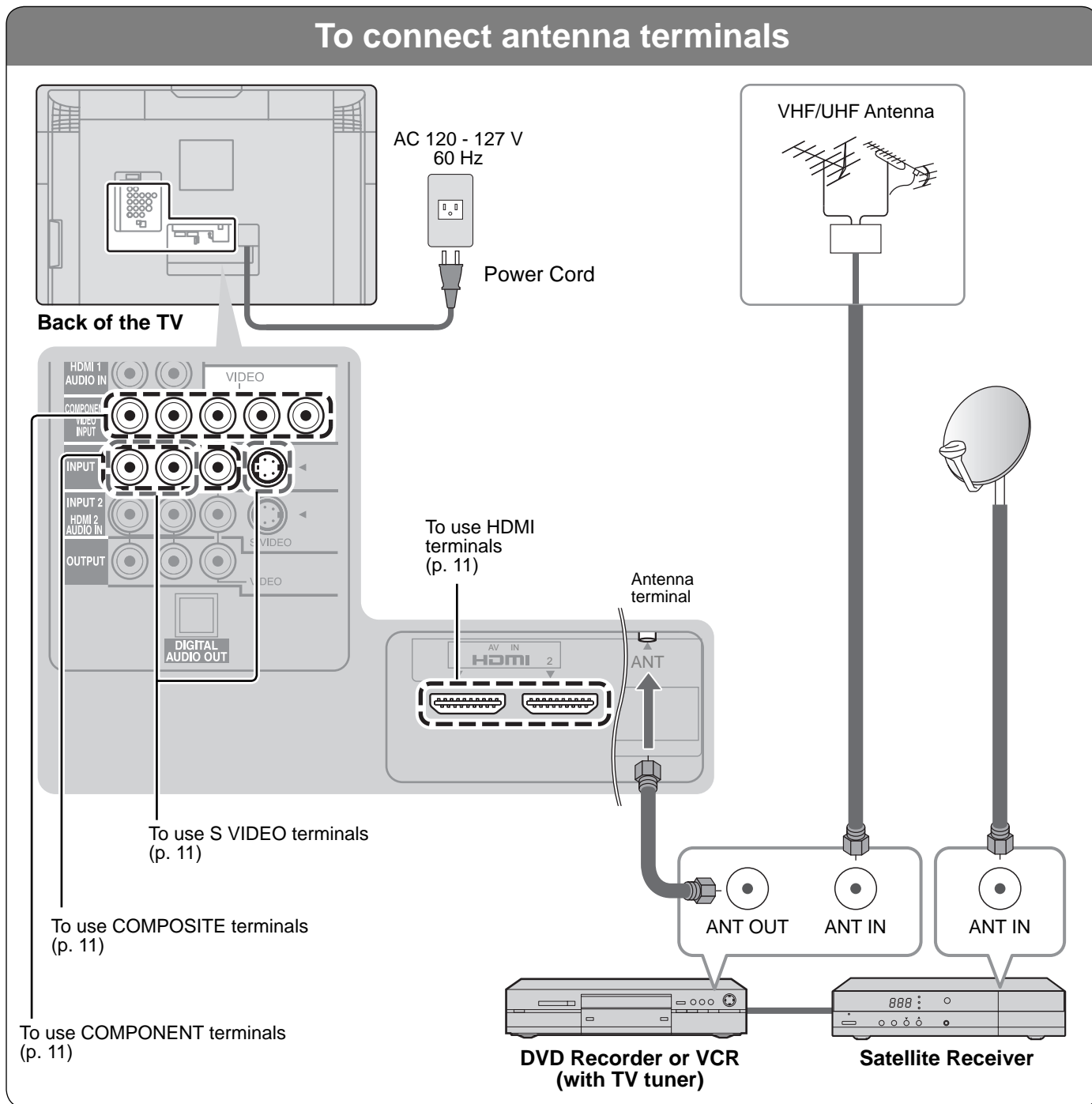

Connecting TV and DVD recorder (VCR)

Connect in the same way as on p. 11.

To connect DVD recorder and satellite receiver

■ **To use HDMI terminals**

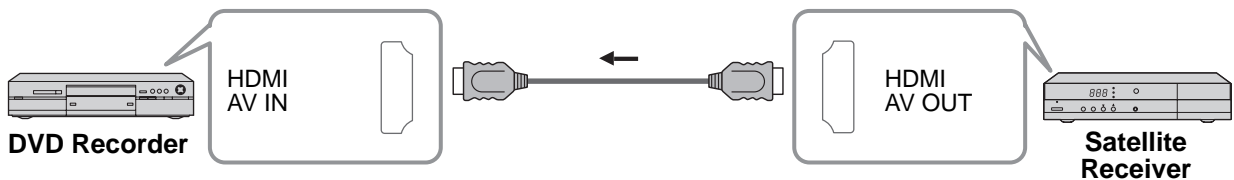

● Connecting to HDMI terminals will enable you to enjoy high-definition digital images and high-quality sound.

■ **To use COMPONENT terminals**

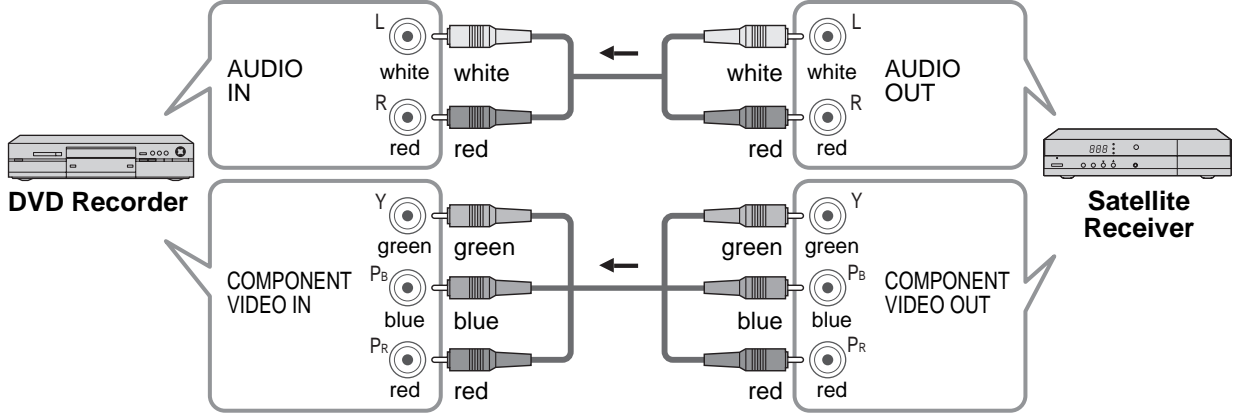

● Satellite Receiver may also be connected to COMPOSITE or S VIDEO terminals. (see below)

To connect VCR and satellite receiver

■ **To use COMPOSITE terminals**

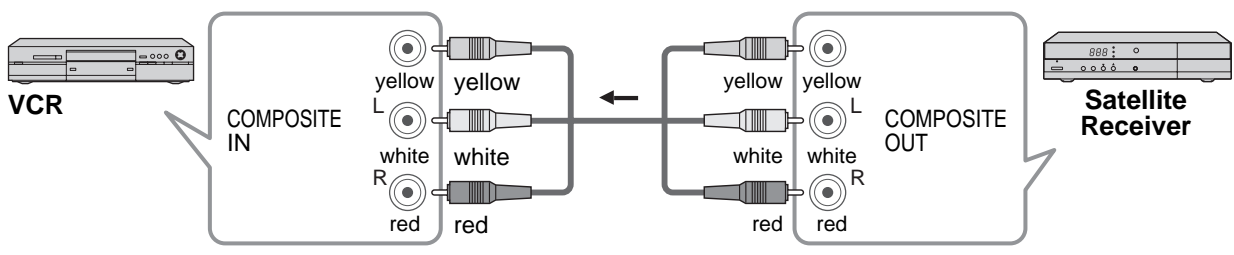

■ **To use S VIDEO terminals**

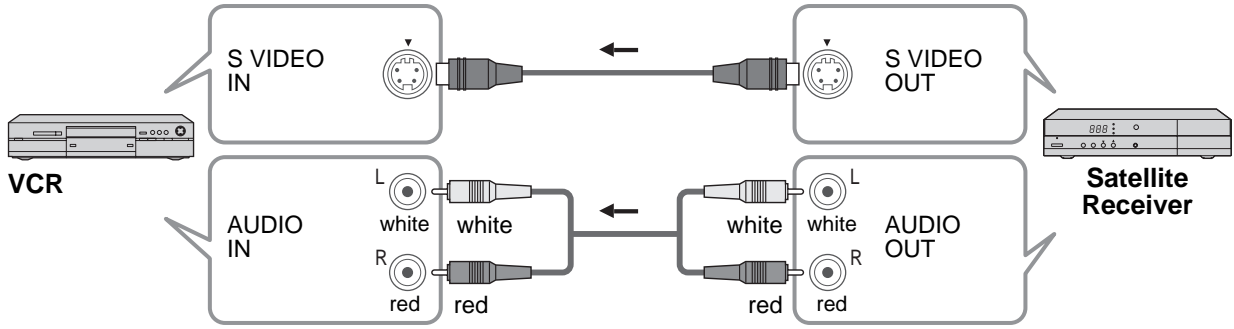

● The S Video input will override the composite video signal when S Video cable is connected. Connect either S Video or Video cable.

● Connecting to S VIDEO terminals will enable you to enjoy greater picture quality than using Composite terminals.

Basic Connection (Continued)

Example 4 Connecting Home Theater and DVD recorder

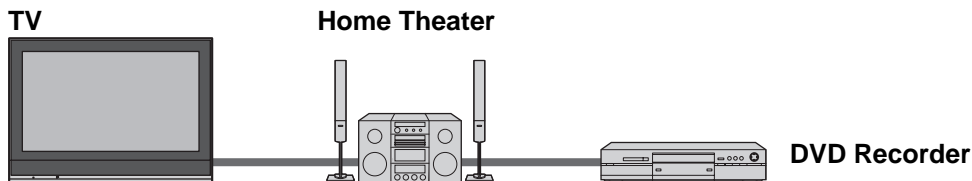

To connect HDMI terminals

Back of the TV

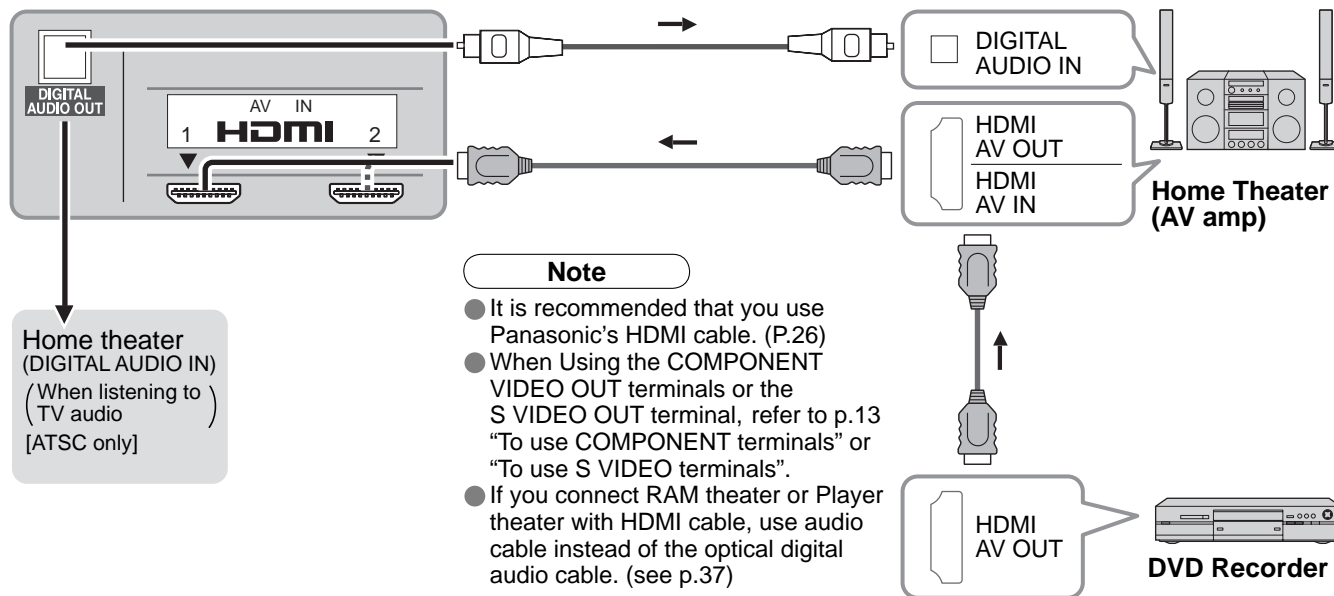

Identifying Controls

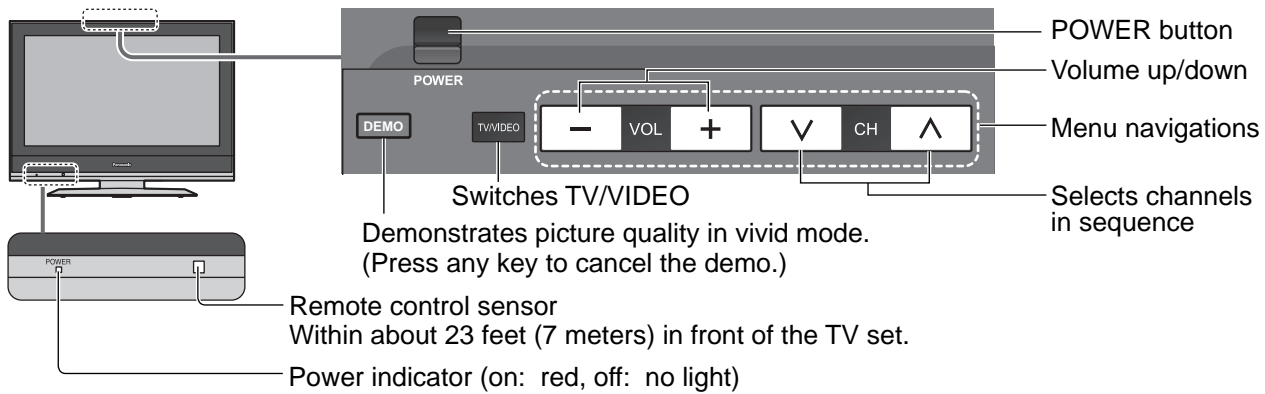

Note

● The TV consumes a limited amount of power as long as the power cord is inserted into the wall outlet.

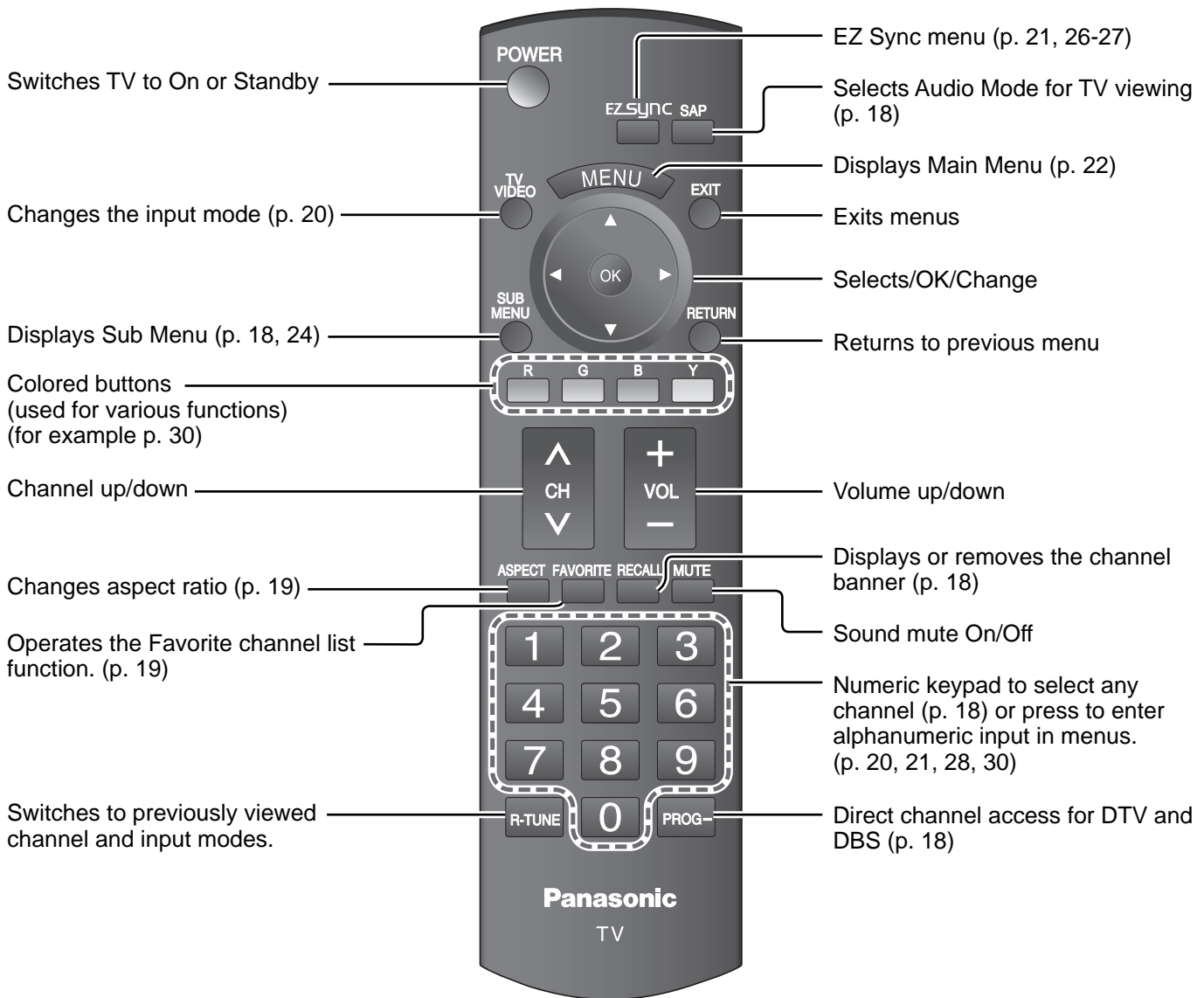

First Time Setup

“First time setup” is displayed only when the TV is turned on for the first time after the power cord is inserted into a wall outlet and when “Auto power on” (p. 24-25) is set to “No”.

1 Turn the TV On with the POWER button

POWER (TV) or POWER (Remote)

2 Select your language

First time setup
Language
Clock
Auto program
Picture

Language
Language English

English ↔ Español ↔ Français

RETURN Go back to previous screen.

3 Adjust the clock

■ Press to exit from menu screen
EXIT

■ Press to return to previous screen
RETURN

First time setup
Language
Clock
Auto program
Picture

Clock
Year 2007
Month 1
Day 7
Hour 10 AM
Minute 10

RETURN Go back to previous screen.

Note

- To change setting (Language/Clock/Auto program/Picture) later, go to Menu screen (p. 22,24)

- Year: Select the year
- Month: Select the month
- Day: Select the day
- Hour: Adjust the hour
- Minute: Adjust the minute

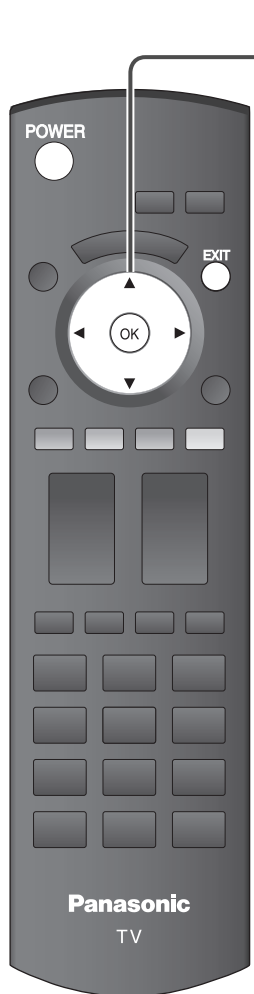

4 Auto channel setup

① Select "Auto program"

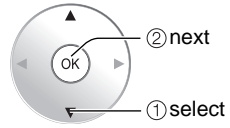
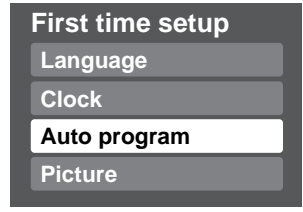

② Select "ANT in"

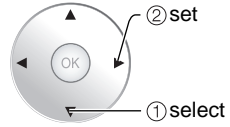
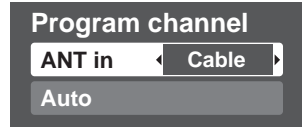

ANT in

Cable: Cable TV
Antenna: Antenna

③ Select "Auto"

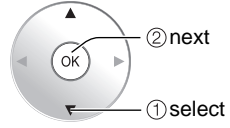
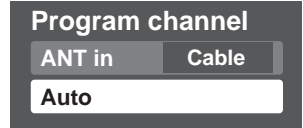

④ Select scanning mode (ALL channels/Analog only/Digital only)

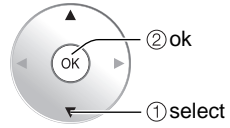
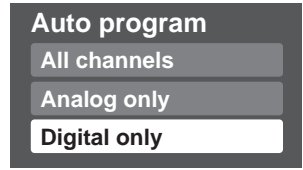

■ Press to exit from menu screen

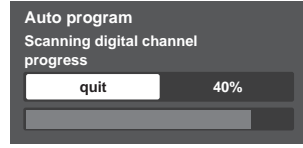

Start scanning the channels

- Available channels (analog/digital) are automatically set.

All channels: Scans digital and analog channels
Analog only: Scans Analog channels only
Digital only: Scans Digital channels only

Note

- About broadcasting systems

Analog (NTSC): traditional TV programming
Digital (ATSC): new programming that allows you to view more channels featuring high-quality video and sound

⑤ Confirm registered channels

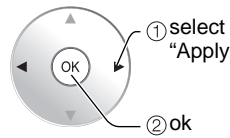
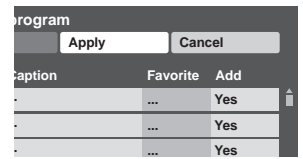

- If OK is not pressed after selecting "Apply", the channels will not be saved.
- If you perform scanning more than twice, previously saved channels are erased.

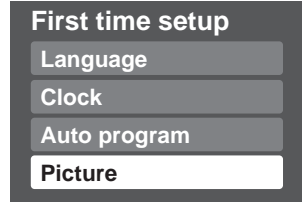

(Refer to p. 22)

Watching TV

Connect the TV to a cable box/cable, set-top-box, satellite box, or antenna cable (p. 8 - 13)

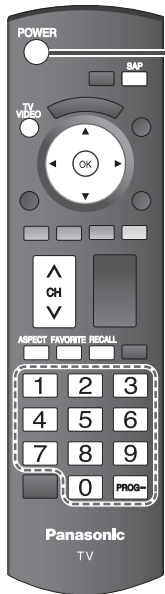

1 Turn power on

POWER



Note

- If the mode is not TV, press **TV VIDEO** and select TV. (p 20)

2 Select a channel number

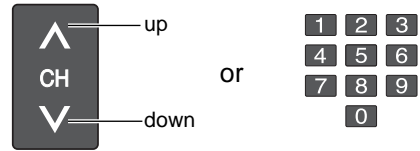

■ To directly input the digital channel number

PROG- When tuning to a digital channel, press the button to enter the minor number in a compound channel number.

example: CH15-1: **1** **5** **PROG-** **1**

■ Other Useful Functions (Operate after 2)

Listen with SAP (Secondary Audio Program)

■ Selects Audio Mode for watching TV



● Digital mode

Press SAP to select the next audio track (if available) when receiving a digital channel.

Audio track 1 of 2
(English)

● Analog mode

Press SAP to select the desired audio mode.

- Each press of SAP will change the audio mode. (Stereo/SAP/Mono)

Display the SUB MENU



■ Press SUB MENU to show sub menu screen. (p.24)

This menu consists of shortcuts to convenient functions.

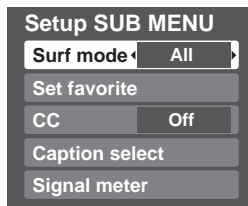

Information Recall



■ Displays or removes the channel banner.

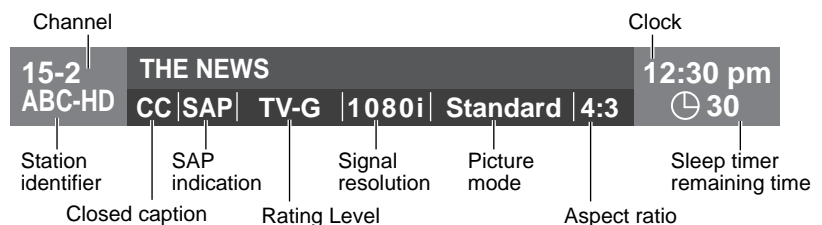

Change aspect ratio

■ Press ASPECT to cycle through the aspect modes. (p. 39)

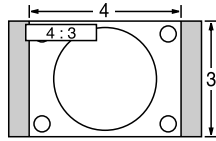

- 480i, 480p: FULL/JUST/4:3/ZOOM
- 1080p, 1080i, 720p: FULL/H-FILL/JUST/4:3/ZOOM

Call up a favorite channel



■ FAVORITE

Channel numbers registered in Favorite are displayed on the favorite tune screen. Select the desired broadcast station with the cursor or use number buttons. (see below)

Note

- The channel number and volume level remain the same even after the TV is turned off.

Set Favorite Feature

- 1 Display the SUB MENU.

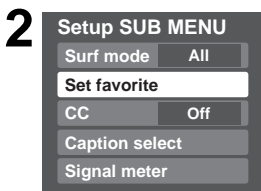
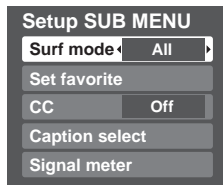

- Press FAVORITE repeatedly to change between pages (1/3, 2/3, 3/3, or exit).

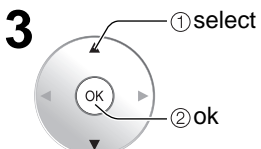
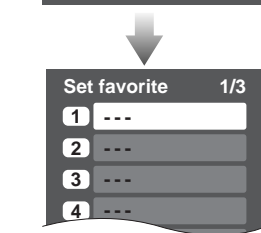

Press ▲▼ to highlight a position on the list. Then, press OK to save the displayed channel in that position.

- You can also use the NUMBER buttons (1-9 and 0) to select a list number (1-9 and 0). By doing so, the displayed channel will be saved on that list number without pressing OK.

● To delete a favorite channel

A saved channel can be removed from the list by holding down OK while its position is highlighted.

● To change the page

Pressing ◀ changes the page backward.

Pressing ▶ changes the page forward.

Use Favorite Feature



Press FAVORITE.

- Press FAVORITE repeatedly to change between pages (1/3, 2/3, 3/3, or exit).

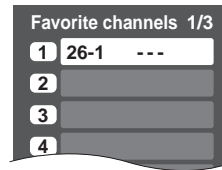

Press ▲▼ or a Numbered key (1-9 and 0) to highlight a channel on the list.

- Selecting a channel number from the list with the number button will display the channel directly.

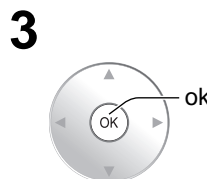

Press OK to display the highlighted channel.

Watching Videos and DVDs

If you have some equipment connected to the TV, you can watch videos and DVDs on the TV's screen.

Input Select

You can select the external equipment to access.



1 With the connected equipment turned On
Display the Input select menu



2 **Select the input mode**

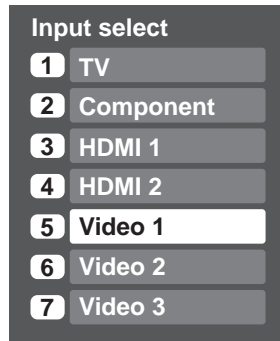

or

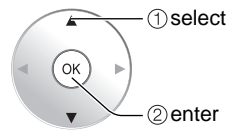

Press corresponding NUMBER button on the remote control to select the input of your choice.

Select the input of your choice, then press OK.

● During the selection, if no action is taken for several seconds, the "Input select" menu disappears.

● The terminal and label of the connected equipment is indicated.
To label each of the input please refer to P. 32-34

(example)



(example)

3 **Operate the connected equipment using the remote control of its own.**

■ Press to return to TV



Note

● For details, see the manual of the equipment.

EZ Sync™

If you connect equipment that has “HDAVI Control 2” function to a TV with HDMI cable, you can enjoy using more convenient functions. For details, “EZ Sync Control” on p. 26-27.

1 Display EZ Sync menu

2 Select the equipment

3 Operate

You can operate the selected equipment with the TV's remote control. Follow the menu of the equipment and enjoy watching. For the remote control operations, refer to p. 27.

■ Press to return to TV



Note

- For details, see the manual of the equipment or ask your local dealer.

How to Use Menu Functions

Various menus allow you to make settings for the picture, sound, and other functions so that you can enjoy watching TV in your own way.

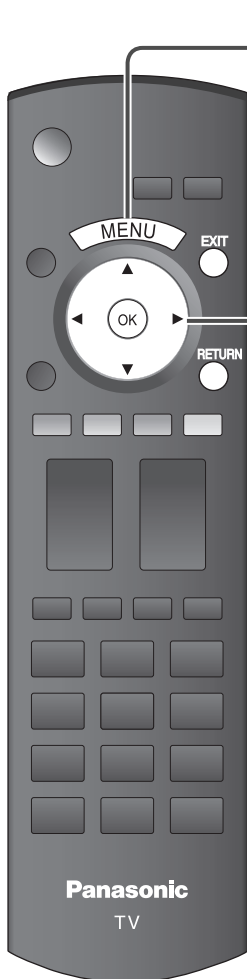

1 Display menu



- Displays the functions that can be set (varies according to the input signal)

2 Select the menu

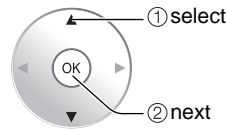
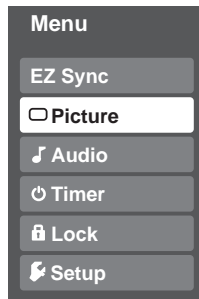

3 Select the item

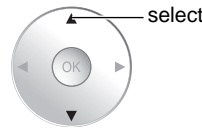
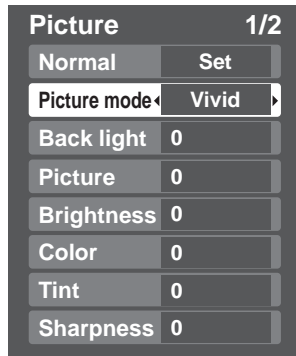

(example: Picture menu)

4 Adjust or select

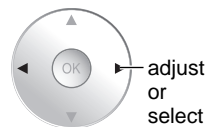
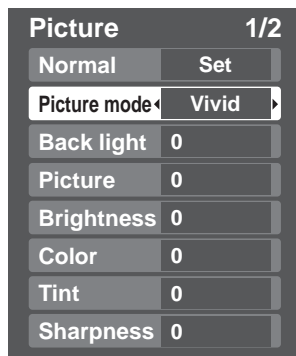

(example: Picture menu)

■ Press to exit from menu screen



■ Press to return to the previous screen



Menu list

Menu	Item		
EZ Sync	DVD recorder, Home theater, HD camcorder, Speaker output		
	Normal		
	Picture mode		
	Back light		
	Picture, Brightness, Color, Tint, Sharpness		
	Color temp.		
	Color mgmt.		
	AI picture		
	Zoom adjust		
	Other adjust	Video NR	
3D Y/C filter			
Color matrix			
MPEG NR			
Black level			
Audio	Normal		
	Bass		
	Treble		
	Balance		
	Other adjust	AI sound	
		Surround	
		Speaker output	
		HDMI 1 in HDMI 2 in	
		Audio leveler	
	Timer	Sleep, Timer 1-5	
Lock			

Adjustments/Configurations (alternatives)

[DVD recorder/Home theater/HD camcorder]

Select equipment to access and operate. (p. 26-27)

[Speaker output]

Select audio output. (**Home theater/TV**) (p. 26-27)

- EZ Sync menu is accessible directly by pressing the EZ Sync button on the remote control. →  (p. 21)

Resets all picture adjustments to factory default settings except for "Other adjust" (Set/No)	Normal <input type="checkbox"/> Set <input type="checkbox"/>
Basic picture mode (Vivid/Standard/Cinema/Custom) (p. 41)	Picture mode <input type="checkbox"/> Vivid <input type="checkbox"/>
Adjusts luminance of the back light.	Back light <input type="checkbox"/> +20 <input type="checkbox"/>
Adjusts color, brightness, etc. for each picture mode to suit your taste	Picture <input type="checkbox"/> +20 <input type="checkbox"/> Tint <input type="checkbox"/> 0 <input type="checkbox"/>
	Brightness <input type="checkbox"/> 0 <input type="checkbox"/> Sharpness <input type="checkbox"/> 0 <input type="checkbox"/>
	Color <input type="checkbox"/> 0 <input type="checkbox"/>
Selects level of warm colors (red) and cool colors (blue) (Cool/Normal/Warm)	Color temp. <input type="checkbox"/> Cool <input type="checkbox"/>
On: Enhances green and blue color reproduction, especially outdoor scenes. (On/Off)	Color mgmt. <input type="checkbox"/> On <input type="checkbox"/>
Controls dark areas without affecting the black level or brightness in the overall picture (On/Off)	AI picture <input type="checkbox"/> On <input type="checkbox"/>
Adjusts vertical alignment and size when aspect setting is "ZOOM" (p. 39)	Zoom adjust <input type="checkbox"/>
Reduces noise, commonly called snow. Leave it off when receiving a strong signal. (Off/On)	Video NR <input type="checkbox"/> Off <input type="checkbox"/>
Minimizes noise and cross-color in the picture. (On/Off)	3D Y/C filter <input type="checkbox"/> Off <input type="checkbox"/>
Selects image resolution of component-connected devices (HD/SD)	Color matrix <input type="checkbox"/> SD <input type="checkbox"/>
<ul style="list-style-type: none"> ● SD: Standard Definition HD: High Definition ● Only 480p signal accepted; regular TV (NTSC) is not available. 	
Reduces noise of specific digital signals of DVD, STB, etc. (On/Off)	MPEG NR <input type="checkbox"/> Off <input type="checkbox"/>
Selects Dark or Light. Valid only for external input signals. (Dark/Light)	Black level <input type="checkbox"/> Light <input type="checkbox"/>
Resets Bass, Treble and Balance adjustments to factory default settings. (Set/No)	Normal <input type="checkbox"/> Set <input type="checkbox"/>
Increases or decreases the bass response.	Bass <input type="checkbox"/> +4 <input type="checkbox"/>
Increases or decreases the treble response.	Treble <input type="checkbox"/> 0 <input type="checkbox"/>
Emphasizes the left / right speaker volume.	Balance <input type="checkbox"/> 0 <input type="checkbox"/>
Equalizes overall volume levels across all channels and external inputs. (On/Off)	AI sound <input type="checkbox"/> On <input type="checkbox"/>
Enhances audio response when listening to stereo. (On/Off) The Surround sound feature does not function when using headphones.	Surround <input type="checkbox"/> Off <input type="checkbox"/>
Switches to "Off" when using external speakers (On/Off)	Speaker output <input type="checkbox"/> On <input type="checkbox"/>
<ul style="list-style-type: none"> ● "AI sound", "Surround", and "Audio leveler" do not work if "Off" is selected 	
Selects according to the signal when HDMI is connected (Auto/Digital/Analog)	HDMI1 in <input type="checkbox"/> Auto <input type="checkbox"/>
<ul style="list-style-type: none"> ● Auto: Automatically selects Analog / Digital signal 	HDMI2 in <input type="checkbox"/> Auto <input type="checkbox"/>
Minimizes volume disparity after switching to external inputs	Audio leveler <input type="checkbox"/> 0 <input type="checkbox"/>
The TV can automatically turn On/Off at the designated date and time (p. 34)	Sleep <input type="checkbox"/> 60 <input type="checkbox"/>
Locks the channels and programs (p. 28)	

- In AV mode, the Audio menu and Setup menu give fewer options.

How to Use Menu Functions

Various menus allow you to make settings for the picture, sound, and other functions so that you can enjoy watching TV in the way best suited for you.

1 Display menu



2 Select "Setup"

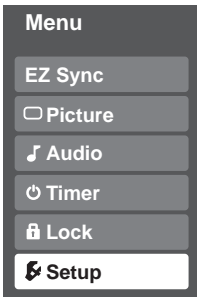

3 Select the item

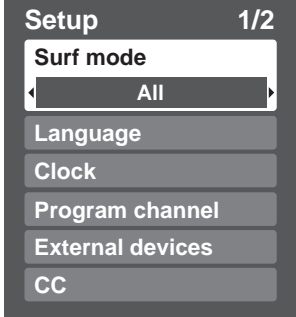

● Displays the functions that can be set (varies according to the input signal)

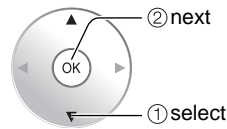
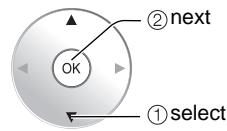

■ Press to exit from menu screen



■ Press to return to the previous screen



1 Display Sub Menu

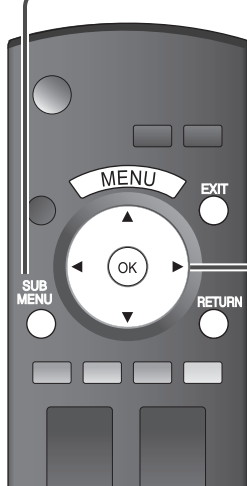

2 Select the item

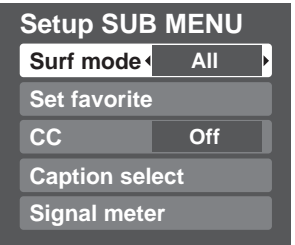
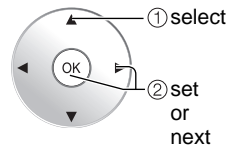
■ Menu list

Menu	Item		
Setup	Surf mode		
	Language		
	Clock		
	Program channel		
	External devices	Input labels	
		Monitor out	
	CC		
	EZ Sync setting	EZ Sync	
		Power off link	
		Power on link	
Default speakers			
Other adjust	Auto power on		
	No signal shut-off		
	No action shut-off		
	Power Save		
	About		
Reset			

■ Sub menu list

Menu	Item	
Setup SUB MENU	Surf mode	
	Set favorite	
	CC	
	Caption select	
	Signal meter	

(Continued)

Adjustments/Configurations (alternatives)	
Sets the mode to select the channel with Channel up/down button (Favorite./All) ● Favorite.: Only channels registered as FAVORITE (p. 31)	Surf mode <input type="radio"/> All <input checked="" type="radio"/>
Selects the screen menu language (p. 16)	Language <input type="text"/>
Adjusts the clock (p. 16)	Clock <input type="text"/>
Sets channels (p. 30)	Program channel <input type="text"/>
Selects the terminal and label of the external equipment (p. 32)	
[Comp./HDMI 1/HDMI 2/Video 1/Video 2/Video 3] To prevent howling and image oscillation, stops output of the pictures and audio specified in this menu. (p. 32) (On/Off)	
Displays subtitles (Closed Caption) (p. 32)	CC <input type="text"/>
Controls equipment connected to HDMI terminals (p. 26) (On/Off) ● "Power off link", "Power on link", and "Default speakers" cannot be selected if "Off" is set.	EZ Sync <input type="radio"/> On <input checked="" type="radio"/>
Sets "Power off link" of HDMI connection equipment (p. 26) (Set/No)	Power off link <input type="radio"/> Set <input checked="" type="radio"/>
Sets "Power on link" of HDMI connection equipment (p. 26) (Set/No)	Power on link <input type="radio"/> Set <input checked="" type="radio"/>
Selects the default speakers (p. 26) (TV/Theater)	Default speakers <input type="radio"/> TV <input checked="" type="radio"/>
Turns TV On automatically when the cable box or a connected device is turned On (No/Set) ● The "Sleep" timer, "On / Off timer", and "First time setup" will not function if "Auto power on" is set. (p. 34)	Auto power on <input type="radio"/> No <input checked="" type="radio"/>
To conserve energy, the TV automatically turns off when NO SIGNAL continues more than 10 minutes. (Set/No) Note ● Not in use when setting "Auto power on", "On/Off Timer", "Lock", or Digital channel. ● "No signal shut-off was activated" will be displayed for about 10 seconds when the TV is turned on for the first time after turning the power off by "No signal shut-off". ● The on-screen display will flash 3, 2 and 1 to indicate the last three (3) remaining minutes prior to the shut-off.	No signal shut-off <input type="radio"/> Set <input checked="" type="radio"/>
To conserve energy, the TV automatically turns off when no operation of remote or front panel key continues more than 3 hours. (No/Set) Note ● Not in use when setting "Auto power on" or "On/Off Timer". ● "No action shut-off was activated" will be displayed for about 10 seconds when the TV is turned on for the first time after turning the power off by "No action shut off". ● The on-screen display will flash 3, 2 and 1 to indicate the last three (3) remaining minutes prior to the shut-off.	No action shut-off <input type="radio"/> No <input checked="" type="radio"/>
Reduces screen brightness to lower power consumption. Eye-friendly for viewing in a dark room. (Standard/Saving)	Power Save <input type="radio"/> Standard <input checked="" type="radio"/>
Displays TV version and software license.	About <input type="text"/>
Performing Reset will clear all items set with Setup, such as channel settings. (p. 30)	Reset <input type="text"/>

Adjustments/Configurations (alternatives)	
Sets the mode to select the channel with Channel up/down button (Favorite./All)	
Sets favorite channels. (p. 19)	
Displays Closed Caption. (p. 32-33)	
Changes the station identifier. (p. 30-31)	
Checks the signal strength if interference or freezing occurs on a digital image. (p. 30-31)	

EZ Sync™ “HDAVI Control™”*

* Simultaneously control all Panasonic “HDAVI Control” equipped components using one button on one remote.

Enjoy additional HDMI Inter-Operability with Panasonic products which have “HDAVI Control” function.

This TV supports “HDAVI Control 2” function.

Connections to some Panasonic equipment (DVD Recorder DIGA, HD Camcorder, RAM theater, Player theater, Amplifier, etc.) with HDMI cables allow you to interface automatically.

The equipment with “HDAVI Control” function enables the following operations:

Automatic Input Switching, Power on link, Power off link and Speaker control (p. 27).

In addition, the equipment with “HDAVI Control 2” function enables the following operation:

EZ Sync Control only with TV’s remote control (for “HDAVI Control 2”) (p. 27).

EZ Sync “HDAVI Control”, based on the control functions provided by HDMI which is an industry standard known as HDMI CEC (Consumer Electronics Control), is a unique function that we have developed and added.

As such, its operation with other manufacturers’ equipment that supports HDMI CEC cannot be guaranteed.

■ **For the first time / When adding a new equipment, reconnecting the equipment, or changing the setup.**

After the connection turn the equipment on and then switch the TV on.

Select the input mode to HDMI 1 or HDMI 2 (p. 20), and make sure that an image is displayed correctly.

● This function needs an HDMI compliant (fully wired) cable. Non-HDMI-compliant cables cannot be utilized. It is recommended that you use Panasonic’s HDMI cable.

Recommended part number:

RP-CDHG15 (4.9 ft./1.5 m), RP-CDHG30 (9.8 ft./3.0 m), RP-CDHG50 (16.4 ft./5.0 m)

1 Display menu
 MENU

2 Select “Setup”
 Menu
 EZ Sync
 Picture
 Audio
 Timer
 Lock
 Setup

3 Select “EZ Sync setting”
 Setup 2/2
 EZ Sync setting
 Other adjust

4 Select “EZ Sync”
 EZ Sync setting
 EZ Sync On
 Power off link Set
 Set

5 Select “On”
 (default is On)
 change

● Press to exit from menu screen
 EXIT

● Press to return to the previous screen
 RETURN

Automatic Input Switching

Speaker control

EZ Sync Control only with TV’s remote control (for “HDAVI Control 2”)

Power on link

Power off link

Default speakers

One-touch theater playback

● If no HDMI equipment is connected or standard HDMI equipment (non- “EZ Sync”) is used, set to “Off”.

At the start of the DIGA, Player theater, or RAM theater playback, the TV's input automatically switches to the input based on the playback equipment.

- For the RAM theater, the speakers automatically switch to the theater system.
If using the DIGA operation, the TV's input automatically switches to the DIGA and DIGA menu is displayed.

You can select Home theater, or TV speakers for audio output.
Control theater speakers with the TV's remote control.
This function is available only when Panasonic Amplifier or Player theater is connected.

- 1 Press 
- 2 Select "Speaker output"
- 3 Select "Home theater" or "TV"

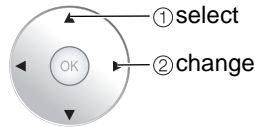
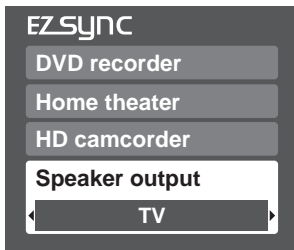

■ **Home theater:** Adjustment for equipment

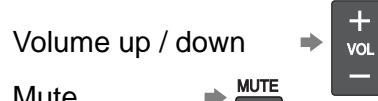

- The sound of TV is muted.
- When the equipment is turned off, TV speakers become active.
- Selecting "Home theater" turns the equipment on automatically if it is in standby mode.

■ **TV:** The TV speakers are active.



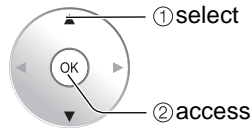

In the EZ Sync menu, you can select an HDMI connected Panasonic equipment and access it quickly. Continue using your TV's remote control to operate the equipment, pointing it at the TV.

- 1 Press 
- 2 Select the equipment you want to access.



You can select available items only.

■ **Available TV's remote control buttons**

	Move the cursor/Select
	Set/Access
	Return to the previous menu
	Display the Functions menu on the equipment
	Available when the purpose of the keys are displayed on screen

- 3 Operate the equipment with the TV's remote control, pointing it at the TV.

- To operate the equipment, read the manual of the equipment.

When "Set" is selected (p.25), TV is turned on automatically and switches to the appropriate HDMI input whenever EZ Sync compatible equipment is initially turned on and Play mode is selected.

When "Set" is selected (p.25) and the TV is turned off, all connected EZ Sync compatible equipment is also automatically turned off.

- DIGA (Panasonic DVD Recorder) will not turn off if it is still in rec mode.
- Caution:** The TV remains on even if the EZ Sync compatible equipment is turned off.

"TV" is the default setting. To set the Home Theater system as default speakers, change the default speakers setting from "TV" to "Theater". Sound will be output from the Home Theater whenever the TV is powered on.

If the "ONE TOUCH PLAY" key is pressed on the remote control for Panasonic Home Theater system, the following sequence of operations is performed automatically.

- 1 Home Theater power switches On, and playback begins.
- 2 TV power switches On, and the playback screen is displayed.
- 3 Audio is muted on the TV and switches to the theater system.

Lock

You can lock specified channels or shows to prevent children from watching objectionable content.

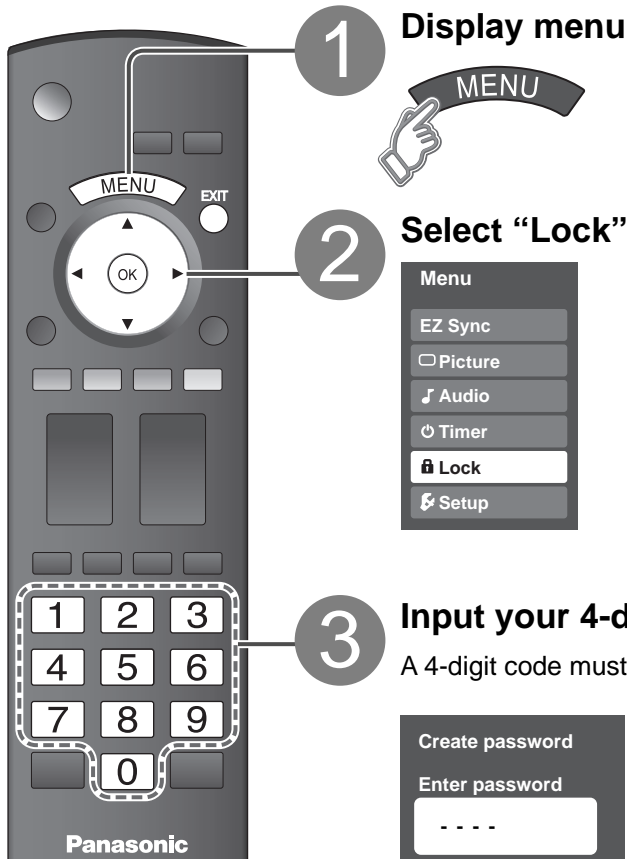

1 Display menu



2 Select "Lock"

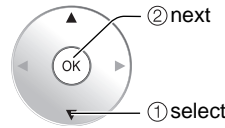
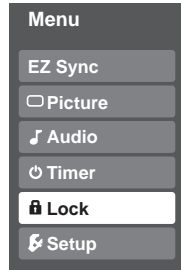

You will be asked to enter your password each time you display the Lock menu.

3 Input your 4-digit password

A 4-digit code must be entered to view a blocked program or change rating settings.

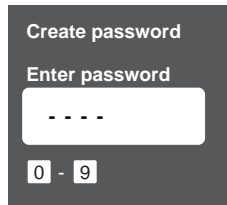

● If it is the first time to enter the password, enter the code twice in order to register it.

Press to exit from menu screen



Caution

● Make a note of your password in case you forget it. (If you have forgotten your password, consult your local dealer.)

4 Select the Lock mode

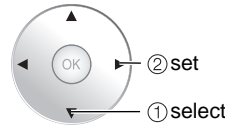
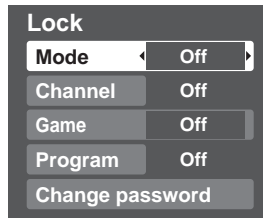

- Off: Unlocks all the lock setting of "Channel", "Game" and "Program".
- All: Locks all the inputs regardless of the lock setting of "Channel", "Game" and "Program".
- Custom: Locks specified inputs of "Channel", "Game" and "Program".

Note

● When you select a locked channel, a message will be displayed that allows you to view the channel if you input your password.

5 Select the item

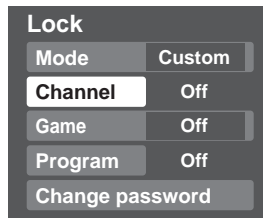

● "Channel", "Game" and "Program" will grey out unless "Custom" is selected in "Mode".

6 Set

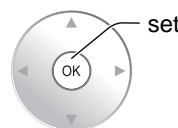

■ To select the channel or the rating of the program to be locked

Channel lock

Select up to 7 (1-7) channels to be blocked. These channels will be blocked regardless of the program rating.

- ① Select "Mode" and set to "Custom"
- ② Select channel to lock.

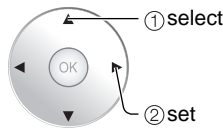
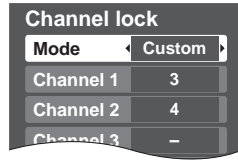

- To lock/unlock all channels: Select "Mode" and set to "All" or "Off".
All: Locks all channels
Off: Unlocks all channels

Game lock

Locks Channel 3, Channel 4 and external inputs.

Select "Game" in ⑤ and set to "On".

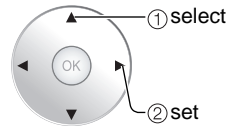

- On: Locks
- Off: Unlocks

Program lock

■ To set a rating level
"V-chip" technology enables restricted shows to be locked according to TV ratings.

- ① Select "Mode" and set to "On".

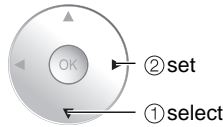
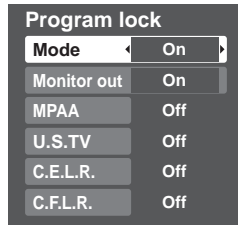

- ③ Select the rating to be locked

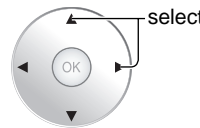

Example of "MPAA" (U.S movie ratings)

NR	No rating
G	General Audience: All ages admitted
PG	Parental Guidance Suggested
PG-13	Parents Strongly Cautioned: Inappropriate for children under 13
R	Restricted: Under 17 requires accompanying parent or adult guardian
NC-17	No one 17 and under admitted
X	Adults only

- To get other information (p. 38)

- ② Select the rating category you wish to follow

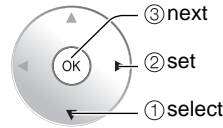
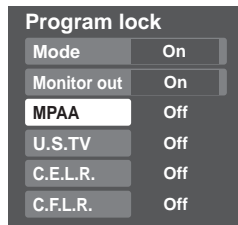

- MPAA: U.S movie ratings
- U.S.TV: U.S TV program ratings
- C.E.L.R.: Canadian English ratings
- C.F.L.R.: Canadian French ratings

■ To disable recording of the locked program

- ➔ Select "Monitor out" and set to "On".

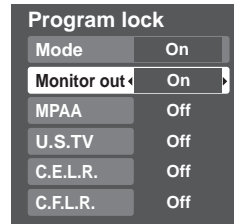

- On: Turns on the monitor terminal output for programs that have been set to "Blocked."
- Off: Turns off the monitor terminal output for programs that have been set to "Blocked."

Change password

■ To change the password

- ① In ④, select "Change password" and press OK
- ② Input the new 4-digit password twice

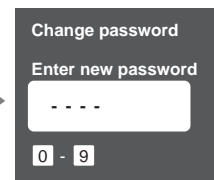
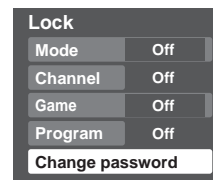

Note

- This television is designed to support the "Downloadable U.S. Region Rating System" when available. (Available only in U.S.A.)
- The Off rating is independent of other ratings.
- When placing a block on a specific-age-based-rating level, the Off rating and any other more restrictive ratings will also be blocked.

Editing and Setting Channels

The current channel settings can be changed according to your needs and reception conditions.

1 Display menu

2 Select "Setup"

3 Select "Program channel"

4 Select the function

5 Set

■ Press to exit from menu screen

EXIT

Menu

- EZ Sync
- Picture
- Audio
- Timer
- Lock
- Setup

Setup 1/2

- Surf mode
- All
- Language
- Clock
- Program channel
- External devices
- CC

Program channel

- ANT in Cable
- Auto
- Manual
- Signal meter

② next

① select

② next

① select

② next

① select

Auto
Set automatically

Manual
Set manually

Signal meter
Check signal strength

■ To reset the settings of setup menu

- ① Select "Reset" in Setup menu (3) and press OK
- ② Input your 4-digit password with number buttons
- ③ Select "YES" on the confirmation screen and press OK

Automatically searches and adds active channels to memory.

① **Select “ANT in”** → Select Cable or Antenna (p. 17)

② **Select “Auto”**

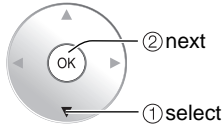
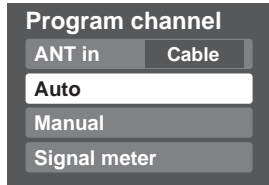

③ **Select scanning mode** (p. 17)

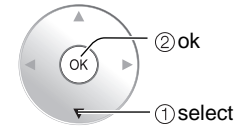
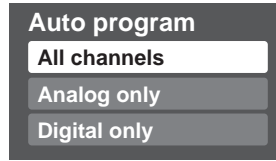

Settings are made automatically

- After completing the setting, select “Apply”. (see below ⑤).
- All previously saved channels are erased.

Use this procedure when changing setting of receiving channels or changing the channel display. Also, use to add or skip channels from channel list manually.

① **Select “Edit”**

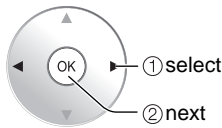
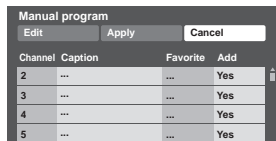

② **Select the item to be edited**

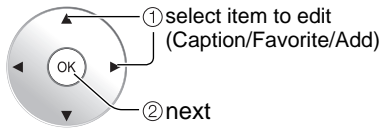
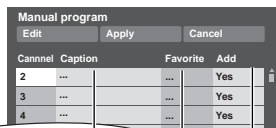

- **Caption:** Changes the station identifier
- **Favorite:** Registers channel to Favorite List
- **Add:** Adds or skips channels



③ **Edit**

● **Caption**

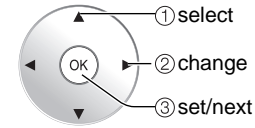

Caption

Select the station identifier

Caption detail

Rename (maximum 7 characters available)

● **Favorite**

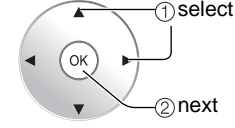
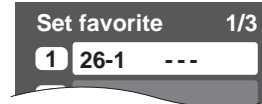

Set favorite

Select the number

● **Add**

Press OK to select “Yes (add)” or “No (skip)”

④ **Move cursor to a channel number**

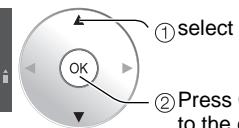
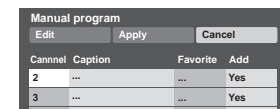

⑤ **Select “Apply”**

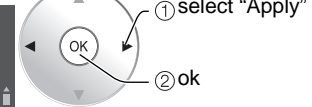
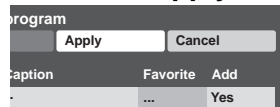

To cancel the Edit

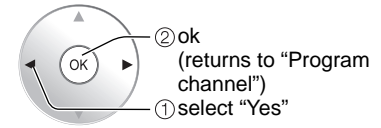
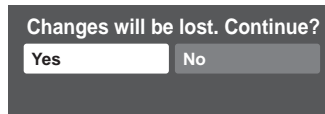
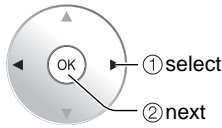
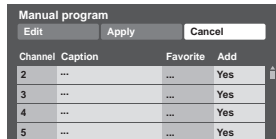

Check the signal strength if interference is found or freezing occurs on a digital image.

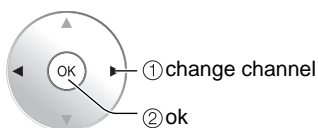
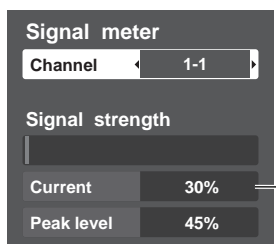

- If the signal is weak, check the antenna. If no problem is found, consult your local dealer.

Note

- Not available if “Cable” is selected in “ANT in” (see above).
- Effective only for digital antenna channels.

● If “Lock” (p. 28) is activated and “Program channel” is selected, “Enter password.” will be displayed.

Input Labels/Monitor out/



1 Display menu

2 Select "Setup"

3 Select "External devices" or "CC"

4 (External devices) Select "Input labels" or "Monitor out"

5 Set

■ Press to exit from menu screen

EXIT

Menu

- EZ Sync
- Picture
- Audio
- Timer
- Lock
- Setup

Setup 1/2

- Surf mode
- All
- Language
- Clock
- Program channel
- External devices
- CC

External devices

- Input labels
- Monitor out

next

select

Input labels

Display labels of external devices

Monitor out

Stop output the picture and audio

CC

Display Closed Caption

Closed Caption

Devices connected to external input terminals can be labeled for easier identification during input selection. (In selecting input mode from p. 20 ②)

■ Select the terminal and label of the external equipment

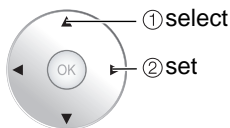
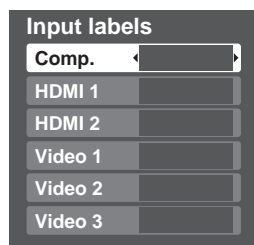

- Terminals: Comp./HDMI 1-2/Video1-3
- Label: SKIP*/VCR/DVD/CABLE/DBS/PVR/GAME/AUX/[BLANK]
- * If "SKIP" is selected, the TV/VIDEO button press will skip its input.

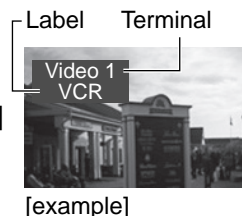

To prevent howling and image oscillation, stops output of the pictures and audio specified in this menu. (p. 24)

■ Select the terminal and set "Off"

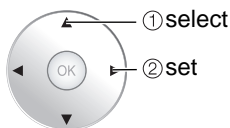
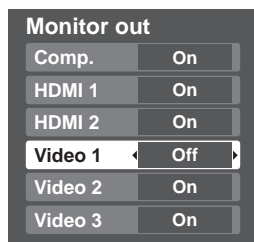

- Select "Off" to stop output of picture and audio. (Video 1/Video 2/Video 3)
- Comp./HDMI 1/HDMI 2 cannot output video signals regardless of "Monitor out" setting. When equipment (STB, DVD, etc.) is connected to HDMI or COMPONENT terminals, only audio signals can be obtained. From the output terminals, no video signals can be passed.

The television includes a built-in decoder that is capable of providing a text display of the audio. The program being viewed must be transmitting Closed Caption (CC) information. (p. 39)

■ Select the item and set

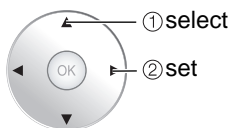
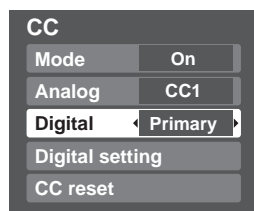

- The settings in "Analog" or "Digital" depend on the broadcaster.

Mode	Select "On" (when not using, select "Off").
Analog	(Choose the Closed Caption service of Analog broadcasting.)
CC1-4:	Information related to pictures (Appears at bottom of screen)
T1-4:	Textual information (Appears over entire screen)
Digital	(The Digital Closed Caption menu lets you configure the way you choose to view the digital captioning.)

Select the setting.

- "Primary", "Second.", "Service 3", "Service 4", "Service 5", "Service 6"

■ To make more in-depth display settings in digital programs

- ① Select "Digital setting" and press OK
- ② Select the item and set

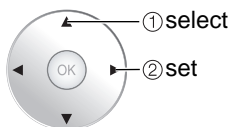
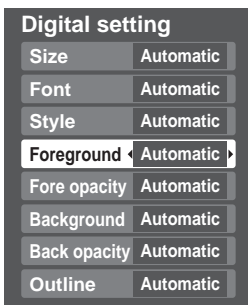

- Size: Text size
- Font: Text font
- Style: Text style (Raised, Depressed, etc.)
- Foreground: Color of text
- Fore opacity: Opacity of text
- Background: Color of text box
- Back opacity: Opacity of text box
- Outline: Outline color of text (Identify the setting options on the screen.)

■ To reset the settings

Select "CC reset" and press OK

Using Timer

The TV can automatically turn On/Off at the designated date and time.

- The Clock must be set before On time/Off time settings. (p. 16)
- The “Sleep” timer and “On / Off timer” will not function if “Auto power on” (p. 25) is set.

1 Display menu

2 Select “Timer”

3 Select the timer to set

■ Press to exit from menu screen



■ Press to return to the previous screen



Sleep	Turns Off automatically
Timer 1	Turns On/Off automatically (5 timers can be set.)
Timer 5	

4 Set the timer

■ To set “Sleep” (Off Timer)

Set to shut the unit off after a pre-selected amount of time.

● 0/30/60/90 (minutes)

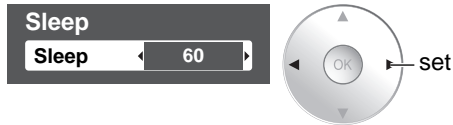

■ To set “Timer 1-5” (On/Off Timer)

Select the item and set

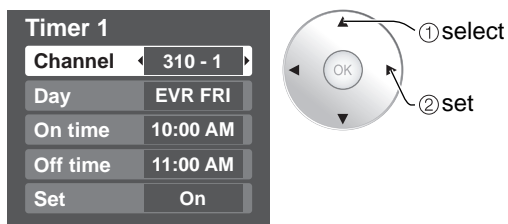

Channel Select the channel

Day Select the day

SUN/MON/TUE/WED/THU/FRI/SAT
 (displays the nearest future date)
 MON-FRI/SAT-SUN/DAILY/EVR SUN/EVR MON/
 EVR TUE/EVR WED/EVR THU/EVR FRI/ EVR SAT

On time The time to turn On

Off time The time to turn Off

Set Timer setting (On/Off)

Note

- The TV automatically turns Off after 90 minutes when turned On by the Timer. This operation will be cancelled if the Off time is selected or if a key is pressed.

Recommended AV Connections

These diagrams show our recommendations for how to connect the TV unit to your various equipment. For other connections, consult the instructions of each piece of equipment and the specifications (p. 44). For additional assistance, please visit our website at: www.panasonic.com
www.panasonic.ca

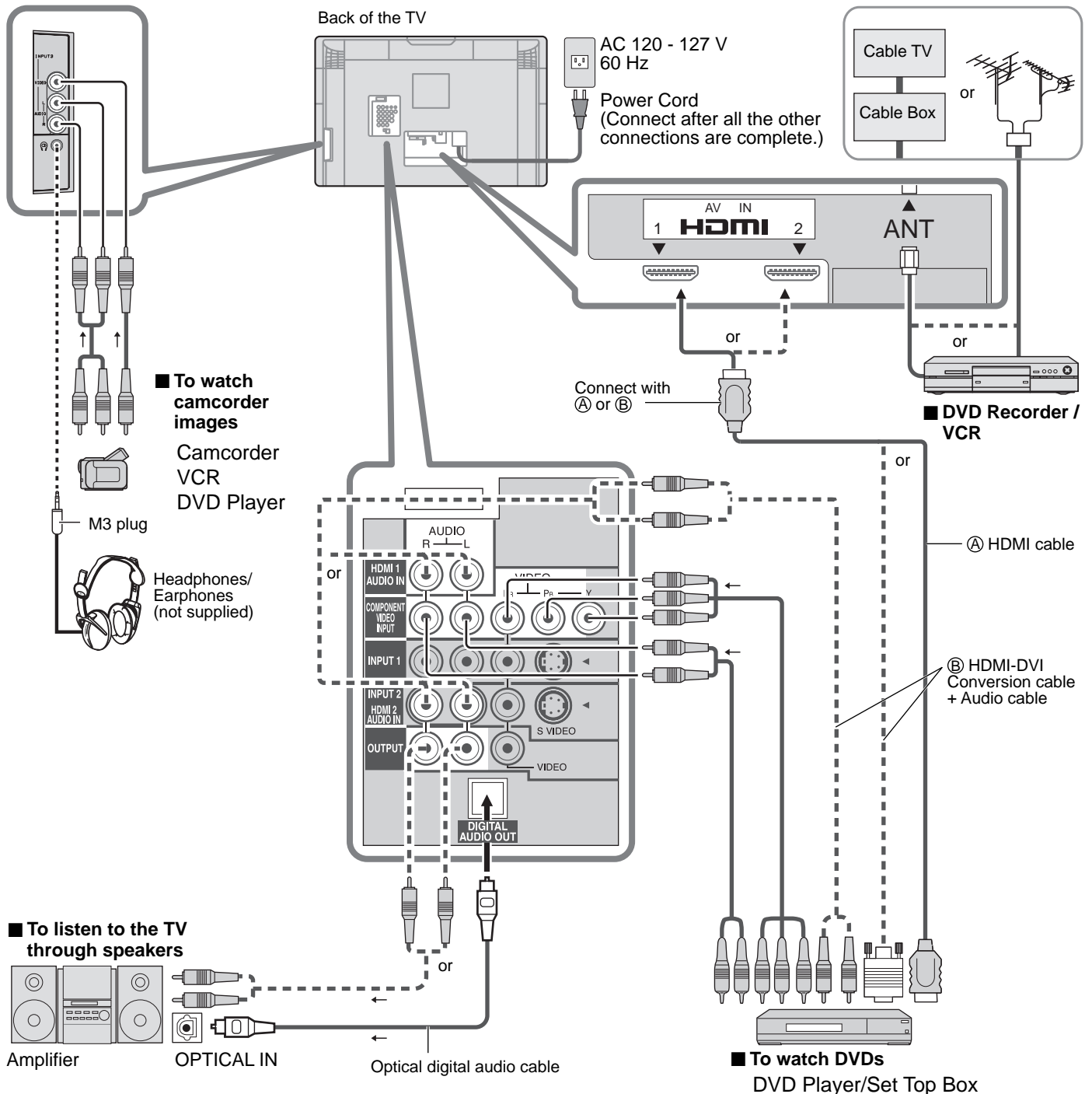

Note

- The picture and audio input signals connected to a terminal specified in "Monitor out" (p. 32) cannot be output from "OUTPUT" terminals. However, audio output can be obtained from "DIGITAL AUDIO OUT" terminal.
- To prevent howling and image oscillation, set the "Monitor out" setting when connecting the VCR with loop-connection. (p. 24, 32)

- When equipment (STB, DVD, etc.) is connected to HDMI or COMPONENT terminals, only audio signals can be obtained. From the output terminals, no video signals can be passed.
- When receiving digital channel signals, all digital formats are down-converted to composite NTSC video to be output through the OUTPUT terminals.

EZ Sync™ Connections

Follow the connection diagrams below for HDAVI control of a single AV piece of equipment such as a Panasonic DIGA-DVD recorder, RAM theater, or Player theater system. Refer to page 26-27 for Setup Menu settings and additional control information.

● Optional HDMI and/or optical cables are not provided.

If connection (or setting) of equipment compatible with HDAVI control is changed, switch the power of this unit Off then On again while the power of all equipment is On (so that the unit can correctly recognize the connected equipment) and check that DIGA, RAM theater, and Player theater playback operate.

Note

● HDMI 1 is recommended.

When connecting to HDMI 2, set the input mode to HDMI 2 (p. 20) initially before connecting to HDMI 2. After connection, confirm the HDMI control functions (p. 26-27).

■ Connecting this unit to a DVD recorder and AV amp

When using an “EZ Sync” audio-video amplifier and a compatible DIGA recorder, use a daisy chain connection as shown below.

■ Connecting this unit to the DIGA, RAM theater, or Player theater

● For DIGA: Connect with HDMI cable

● For RAM theater and Player theater: Connect with the HDMI and audio cables.

If audio cable is not connected, you cannot listen to the TV program through the theater system.

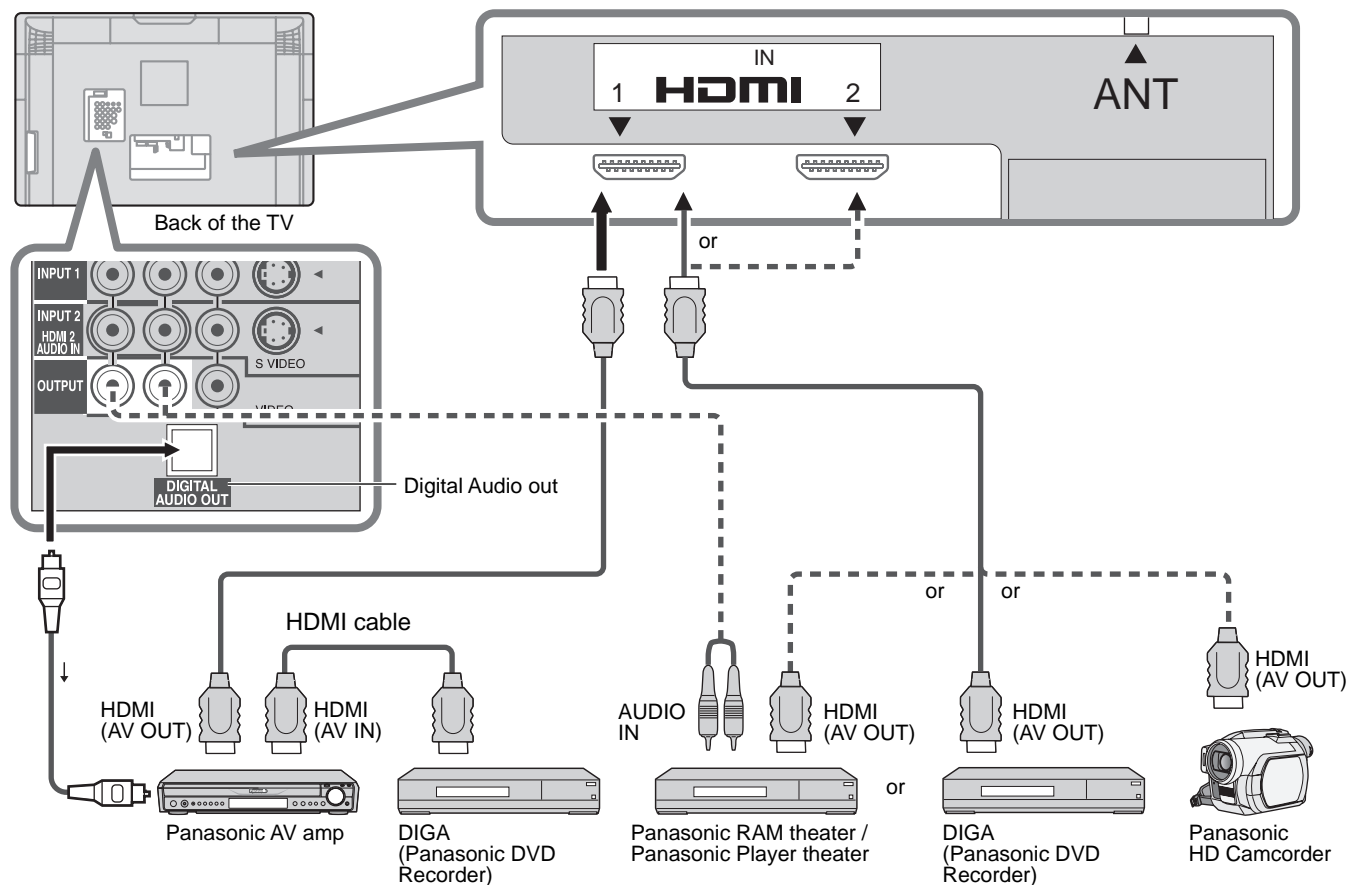

● One AV amp and one DIGA recorder can be operated with this unit.

● Be sure to connect the AV amp between this unit and the DIGA recorder.

■ Setting of this unit after connection

After making connections as shown above, set “EZ Sync” (under “EZ Sync setting”) to “On” using the Setup menu. (p. 26-27).

Note

● Individual components of HDMI equipment may require additional menu settings specific to each model. Please refer to their respective operating instruction manuals.

● When audio from other equipment connected to this unit via HDMI is output using “DIGITAL AUDIO OUT” of this unit, the system switches to 2CH audio.

(When connecting to an AV amp via HDMI, you can enjoy higher sound quality.)

Ratings List for Lock

“V-chip” technology enables you to lock channels or shows according to standard ratings set by the entertainment industry. (p. 29)

■ U.S. MOVIE RATINGS (MPAA)

NR	NO RATING (NOT RATED) AND NA (NOT APPLICABLE) PROGRAMS. Movie has not been rated or rating does not apply.
G	GENERAL AUDIENCES. All ages admitted.
PG	PARENTAL GUIDANCE SUGGESTED. Some material may not be suitable for children.
PG-13	PARENTS STRONGLY CAUTIONED. Some material may be inappropriate for children under 13.
R	RESTRICTED. Under 17 requires accompanying parent or adult guardian.
NC-17	NO ONE 17 AND UNDER ADMITTED.
X	ADULTS ONLY.

■ U.S. TV PROGRAMS RATINGS (U. S. TV)

Age-based Group	Age-based Ratings	Possible Content Selections	Description
NR (Not Rated)	TV-NR	<ul style="list-style-type: none"> ● Viewable ● Blocked 	Not Rated.
Youth	TV-Y	<ul style="list-style-type: none"> ● Viewable ● Blocked 	All children. The themes and elements in this program are specifically designed for a very young audience, including children from ages 2-6.
	TV-Y7	<ul style="list-style-type: none"> ● FV Blocked ● Viewable ● Blocked 	Directed to older children. Themes and elements in this program may include mild physical or comedic violence, or may frighten children under the age of 7.
Guidance	TV-G	<ul style="list-style-type: none"> ● Viewable ● Blocked 	General audience. It contains little or no violence, no strong language, and little or no sexual dialogue or situations.
	TV-PG	<ul style="list-style-type: none"> ● D,L,S,V (all selected) ● Any combination of D, L, S, V 	Parental guidance suggested. The program may contain infrequent coarse language, limited violence, some suggestive sexual dialogue and situations.
	TV-14	<ul style="list-style-type: none"> ● D,L,S,V (all selected) ● Any combination of D, L, S, V 	Parents strongly cautioned. This program may contain sophisticated themes, sexual content, strong language and more intense violence.
	TV-MA	<ul style="list-style-type: none"> ● L,S,V (all selected) ● Any combination of L, S, V 	Mature audiences only. This program may contain mature themes, profane language, graphic violence, and explicit sexual content.

FV: Fantasy/Cartoon Violence. V: Violence S: Sex L: Offensive Language D: Dialogue with sexual content.

■ CANADIAN ENGLISH RATINGS (C. E. L. R.)

E	Exempt - Exempt programming includes: news, sports, documentaries and other information programming, talk shows, music videos, and variety programming.
C	Programming intended for children under age 8. No offensive language, nudity or sexual content.
C8+	Programming generally considered acceptable for children 8 years and over. No profanity, nudity or sexual content.
G	General programming, suitable for all audiences.
PG	Parental Guidance suggested. Some material may not be suitable for children.
14+	Programming contains themes or content which may not be suitable for viewers under the age of 14. Parents are strongly cautioned to exercise discretion in permitting viewing by pre-teens and early teens.
18+	18+ years old. Programming restricted to adults. Contains constant violence or scenes of extreme violence.

■ CANADIAN FRENCH RATINGS (C. F. L. R.)

E	Exempt - Exempt programming.
G	General - Programming intended for audience of all ages. Contains no violence, or the violence content is minimal or is depicted appropriately.
8 ans+	8+ General - Not recommended for young children. Programming intended for a broad audience but contains light or occasional violence. Adult supervision recommended.
13 ans+	Programming may not be suitable for children under the age of 13 - Contains either a few violent scenes or one or more sufficiently violent scenes to affect them. Adult supervision strongly suggested.
16 ans+	Programming may not be suitable for children under the age of 16 - Contains frequent scenes of violence or intense violence.
18 ans+	Programming restricted to adults. Contains constant violence or scenes of extreme violence.

Caution

● The V-Chip system that is used in this set is capable of blocking “NR” programs (non rated, not applicable and none) as per FCC Rules Section 15.120(e)(2). If the option of blocking “NR” programs is chosen “unexpected and possibly confusing results may occur, and you may not receive emergency bulletins or any of the following types of programming:”

- Emergency Bulletins (Such as EAS messages, weather warnings and others)
- Locally originated programming • News • Political • Public Service Announcements • Religious • Sports • Weather

Technical Information

Closed Caption (CC)

- For viewing Closed Caption of digital broadcasting, set the aspect ratio to FULL.
(If viewing with H-FILL, JUST, ZOOM or 4:3, characters will be cut off.)
- The Closed Caption is not displayed when you use HDMI connection.
- If analog connected equipment is used for displaying or recording, Closed Caption (CC) should be set On/Off on the connected equipment.
The CC mode setting of the TV will not affect the analog input.
If a digital program is being output in analog format, the CC data will also be output in analog format.
If digital connected equipment is used for input, CC should be set On on either the connected equipment or the TV.
If CC is set On on both the connected equipment and the TV, captions from each unit will overlap.

Aspect Ratio

Lets you choose the aspect depending on the format of the received signal and your preference. (p. 19)
(e.g.: in case of 4:3 image)

● FULL

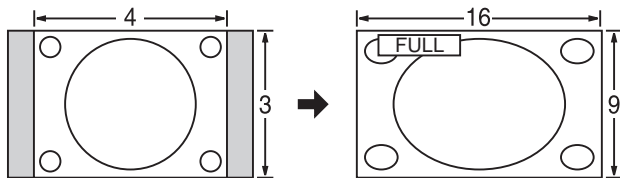

Enlarges the 4:3 image horizontally to the screen's side edges.
(Recommended for anamorphic picture)

● JUST

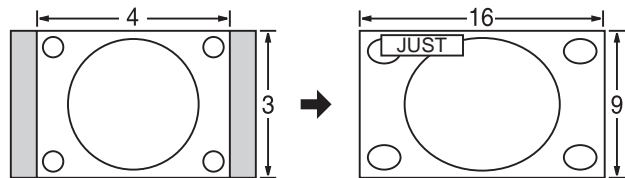

Stretches to justify the 4:3 image to the four corners of the screen.
(Recommended for normal TV broadcast)

● H-FILL

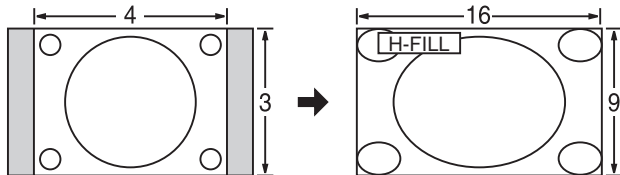

Enlarges the 4:3 image horizontally to the screen's side edges.
The side edges of the image are cut off.

● 4:3

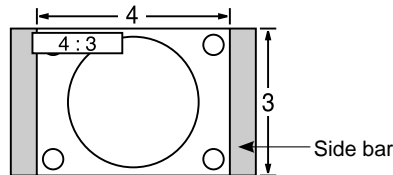

Standard

● ZOOM

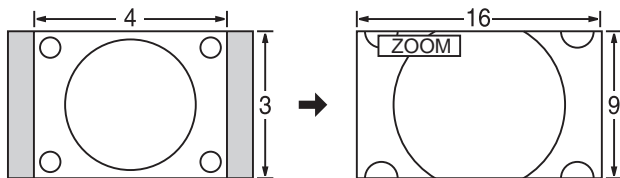

Enlarges the 4:3 image to the entire screen.
(Recommended for Letter Box)

Note

- 480i (4:3), 480i (16:9), 480p (4:3), 480p (16:9):
FULL, JUST, 4:3 or ZOOM
- 1080p / 1080i / 720p:
FULL, H-FILL, JUST, 4:3 or ZOOM
- When the signal is 720p/1080i/1080p, the aspect mode automatically defaults to Full after turning off the TV, after changing input mode, or after changed signal resolution other than 720p/1080i/1080p.

● Zoom adjust

Vertical image position and size can be adjusted in "ZOOM".

- ① Select "Zoom adjust" on the "Picture" menu. (p. 22-23)
- ② V-position: Vertical position adjustment



- ③ V-size: Vertical size adjustment



- To reset the aspect ratio → (OK)

Technical Information (Continued)

DIGITAL AUDIO OUT terminals

You can enjoy your home theater by connecting a Dolby Digital (5.1 channel) decoder and “Multi Channel” amplifier to the DIGITAL AUDIO OUT terminals.

Caution

- Depending on your DVD player and DVD-Audio software the copyright protection function may operate and disable optical output.
- External speakers cannot be connected directly to OUTPUT terminals.
- When an ATSC channel is selected, the output from the DIGITAL AUDIO OUT jack will be Dolby Digital. When an NTSC channel is selected, the output will be PCM.

EZ Sync™ “HDAVI Control™”

HDMI connections to some Panasonic equipment allow you to interface automatically. (p. 26)

- This function may not work normally depending on the equipment condition.
- The equipment can be operated by other remote controls with this function on even if TV is in Standby mode.
- Image or sound may not be available for the first few seconds when the playback starts.
- Image or sound may not be available for the first few seconds when Input mode is switched.
- Volume function will be displayed when adjusting the volume of the equipment.
- If you connect the same kind of equipment at once (for example: one DIGA to HDMI 1 / another DIGA to HDMI 2), EZ Sync™ is available for the terminal with the smaller number.
- If you connect the equipment that has “HDAVI Control 2” function to the TV with HDMI cable, the sound from DIGITAL AUDIO OUT terminal can be output as multi channel surround.

HDMI connection

HDMI (high-definition multimedia interface) allows you to enjoy high-definition digital images and high-quality sound by connecting the TV unit and the devices.

HDMI-compatible equipment (*1) with an HDMI or DVI output terminal, such as a set-top box or a DVD player, can be connected to the HDMI connector using an HDMI compliant (fully wired) cable.

- HDMI is the world's first complete digital consumer AV interface complying with a non-compression standard.
- If the external equipment has only a DVI output, connect to the HDMI terminal via a DVI to HDMI adapter cable (*2).
- When the DVI to HDMI adapter cable is used, connect the audio cable to the audio input terminal.
- Audio settings can be made on the “HDMI 1 in” or “HDMI 2 in” menu screen. (p. 22)
Applicable audio signal sampling frequencies (L.PCM): 48 kHz, 44.1 kHz, 32 kHz

(*1): The HDMI logo is displayed on an HDMI-compliant device.

(*2): Enquire at your local digital equipment retailer shop.

Caution

- Use with a PC is not assumed.
- All signals are reformatted before being displayed on the screen.
- If the connected device has an aspect adjustment function, set the aspect ratio to “16:9”.
- This HDMI connector is “type A”.
- These HDMI connectors are compatible with HDCP (High-Bandwidth Digital Content Protection) copyright protection.
- A device having no digital output terminal may be connected to the input terminal of either “COMPONENT”, “S VIDEO”, or “VIDEO” to receive analog signals.
- The HDMI input terminal can be used with only the following image signals: 480i, 480p, 720p, 1080i and 1080p.
Match the output setting of the digital device.
- For details of the applicable HDMI signals, see next page.

Input signals that can be displayed

* Mark: Applicable input signal for Component (Y, P_B, P_R) and HDMI

	horizontal frequency (kHz)	vertical frequency (Hz)	COMPONENT	HDMI
525 (480) / 60i	15.73	59.94	*	*
525 (480) / 60p	31.47	59.94	*	*
750 (720) / 60p	45.00	59.94	*	*
1,125 (1,080) / 60i	33.75	59.94	*	*
1,125 (1,080) / 60p	67.43	59.94		*
1,125 (1,080) / 60p	67.50	60.00		*

Note

- Signals other than those shown above may not be displayed properly.
- The above signals are reformatted for optimal viewing on your display.

Picture mode

- Vivid (default): Provides enhanced picture contrast and sharpness for viewing in a well-lit room.
- Standard: Recommended for normal viewing conditions with subdued room lighting.
- Cinema: For watching movies in a darkened room. It provides a soft, film-like picture.
- Custom: Customizes each item according to your taste.

Maintenance

First, unplug the Power cord plug from the wall outlet.

Display panel

The front of the display panel has been specially treated. Wipe the panel surface gently using only a cleaning cloth or a soft, lint-free cloth.

- If the surface is particularly dirty, soak a soft, lint-free cloth in diluted neutral detergent (1 part detergent diluted by 100 times the amount of water) and then wring the cloth to remove excess liquid. Use this cloth to wipe the surface of the display panel, then wipe it evenly with a dry cloth of the same type until the surface is dry.
- Do not scratch or hit the surface of the panel with fingernails or other hard objects. Furthermore, avoid contact with volatile substances such as insect sprays, solvents, and thinner; otherwise, the quality of the surface may be adversely affected.

Cabinet

If the cabinet becomes dirty, wipe it with a soft, dry cloth.

- If the cabinet is particularly dirty, soak the cloth in a weak detergent solution and then wring the cloth dry. Use this cloth to wipe the cabinet and then wipe it dry with a dry cloth.
- Do not allow any detergent to come into direct contact with the surface of the LCD TV. If water droplets get inside the unit, operating problems may result.
- Avoid contact with volatile substances such as insect sprays, solvents, and thinner; otherwise, the quality of the cabinet surface may be adversely affected or the coating may peel off. Furthermore, do not leave it for long periods in contact with articles made from rubber or PVC.

Pedestal

Cleaning

- Wipe the surfaces with a soft, dry cloth. If the unit is particularly dirty, clean it using a cloth soaked with water to which a small amount of neutral detergent has been added and then wipe with a dry cloth. Do not use products such as solvents, thinner, or household wax for cleaning, as they can damage the surface coating. (If using a chemically-treated cloth, follow the instructions supplied with the cloth.)
- Do not attach sticky tape or labels, as they can make the surface of the pedestal dirty. Do not allow long-term contact with rubber, vinyl products, or the like. (Doing so will cause deterioration.)

Power cord plug

Wipe the plug with a dry cloth at regular intervals. (Moisture and dust can lead to fire or electrical shock.)

FAQ

Before requesting service or assistance, please follow these simple guides to resolve the problem.
If problem still persists, please contact your local Panasonic dealer or Panasonic Service Center for assistance.
For details (p. 45)
For additional assistance, please contact us via the website at:
www.panasonic.com/contactinfo
www.panasonic.ca

White spots or shadow images (noise)

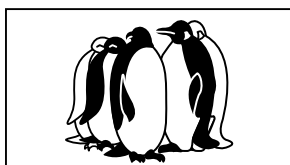

- Check the position, direction, and connection of the aerial.

Interference or frozen digital channels (intermittent sound)



- Change the direction of antenna for digital channels.
- Check "Signal meter" (p. 31). If the signal is weak, check the antenna and consult your local dealer.

The LCD panel moves slightly when it is pushed with a finger A clattered sound might be heard

This is not a malfunction.

- There is some looseness around the panel to prevent the damage to the panel.

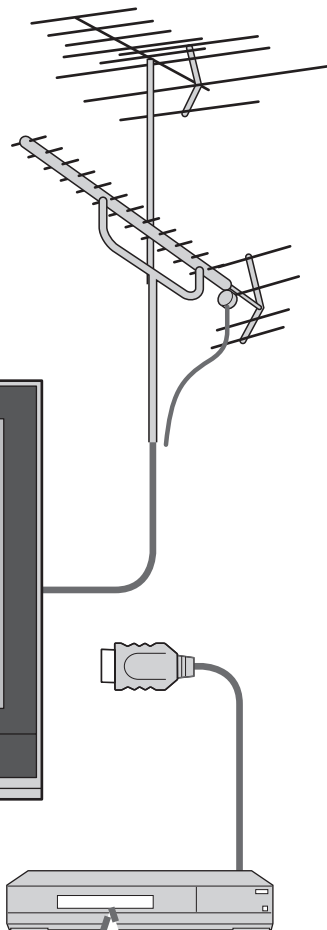

Pictures from external equipment are distorted when the unit is connected via HDMI

- Is the HDMI cable connected properly? (p. 36-37)
- Turn Off the TV unit and equipment, then turn them On again.
- Check an input signal from the equipment. (p. 41)
- Use equipment compliant with EIA/CEA-861/861B.

The remote control does not work

- Are the batteries installed correctly? (p. 6)
- Has the battery run down?



If there is a problem with your TV, please refer to the table below to determine the symptoms, then carry out the suggested check. If this does not solve the problem, please contact your local Panasonic dealer, quoting the model number and serial number (both found on the rear of the TV).

	Problem	Actions
Screen	Chaotic image, noisy	<ul style="list-style-type: none"> ● Check nearby electrical products (car, motorcycle, fluorescent lamp).
	No image can be displayed	<ul style="list-style-type: none"> ● Check Picture menu (p. 22)
	Only spots are displayed instead of images	<ul style="list-style-type: none"> ● Check the channel settings. (p. 30) ● Check the antenna cables.
	Neither image nor sound is produced	<ul style="list-style-type: none"> ● Is the power cord plugged into the outlet? ● Is the TV unit turned On? ● Check Picture menu (p. 22) and volume.
Sound	No sound is produced	<ul style="list-style-type: none"> ● Are the speakers' cables connected correctly? ● Is "Sound Mute" active? (p. 15) ● Is the volume set to the minimum? ● Is "Speaker output" set to "Off"? (p. 22) ● Change "SAP" settings. (p. 18) ● Check "HDMI 1 in" or "HDMI 2 in" settings. (p. 22)
	Sound is unusual	<ul style="list-style-type: none"> ● Set "SAP" setting to "Stereo" or "Mono." ● Check the HDMI device connected to the unit. ● Set the audio setting of the HDMI device to "Linear PCM." ● If digital sound connection has a problem, select analog sound connection.
Other	The main unit is hot.	<ul style="list-style-type: none"> ● The main unit radiates heat and some of the parts may become hot. This is not a problem for performance or quality. Set up in a location with good ventilation. Do not cover the ventilation holes of the TV with a tablecloth, etc., and do not place on top of other equipment.

Specifications

		TC-26LE70	TC-32LE70
Power Source		AC 120 - 127 V, 60 Hz	
Power Consumption	Average use	116 W	132 W
	Maximum Current	2.1 A	2.3 A
	Standby condition	0.1 W	0.1 W
	Aspect Ratio	16:9	
Visible screen size (W x H x Diagonal)		26.0" DIAGONAL (66.1 cm DIAGONAL)	31.5" DIAGONAL (80.0 cm DIAGONAL)
		22.7" x 12.8" x 26.0" (576 mm x 324 mm x 661 mm)	27.5" x 15.4" x 31.5" (698 mm x 392 mm x 800 mm)
	(No. of pixels)	1,049,088 (1,366 (W) x 768(H))	[4,098 x 768 dots]
Sound	Speaker	1 way 2 speakers	
	Audio Output	20 W (10 W x 2) (10 % THD)	
	Headphones	M3 (3.5 mm) Jack x 1	
Channel Capability-ATSC/NTSC (Digital/Analog)		VHF/ UHF: 2 - 69, CATV: 1 - 135	
Operating Conditions		Temperature: 32 °F – 95 °F (0 °C – 35°C) Humidity: 20 % – 80 % RH (non-condensing)	
Connection Terminals	INPUT 1-2	VIDEO: RCA PIN Type x 1 1.0 V [p-p] (75 Ω) S VIDEO: Mini DIN 4-pin Y: 1.0 V [p-p] (75 Ω) C: 0.286 V [p-p] (75 Ω) AUDIO L - R: RCA PIN Type x 2 0.5 V [rms]	
	INPUT 3	VIDEO: RCA PIN Type x 1 1.0 V [p-p] (75 Ω) AUDIO L - R: RCA PIN Type x 2 0.5 V [rms]	
	COMPONENT VIDEO INPUT	Y: 1.0 V [p-p] (including synchronization) PB, PR: ±0.35 V [p-p] AUDIO L-R: RCA PIN Type x 2 0.5 V [rms]	
	HDMI 1-2 AUDIO IN	TYPE A Connector x 2 ● This TV supports "HDAVI Control 2" function. AUDIO L - R: RCA PIN Type x 2 0.5 V [rms]	
	OUTPUT	VIDEO: RCA PIN Type x 1 1.0 V [p-p] (75 Ω) AUDIO L - R: RCA PIN Type x 1 0.5 V [rms]	
	DIGITAL AUDIO OUT	PCM / Dolby Digital, Fiber Optic	
FEATURES		3D Y/C Digital Comb Filter, CLOSED CAPTION, V-Chip HDMI (HDAVI Control 2) Vesa compatible	
Dimensions (W x H x D)	Including TV stand	25.9" x 20.3" x 9.4" (657 mm x 515 mm x 239 mm)	31.1" x 23.3" x 9.4" (791 mm x 592 mm x 239 mm)
	TV Set only	25.9" x 18.4" x 4.6" (657 mm x 468 mm x 117 mm)	31.1" x 21.5" x 4.6" (791 mm x 545 mm x 117 mm)
Mass		31.1 lb. (14.0 kg) NET	36.7 lb. (16.5 kg) NET

[TC-26LE70]

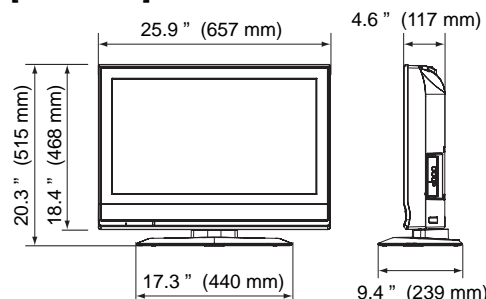

[TC-32LE70]

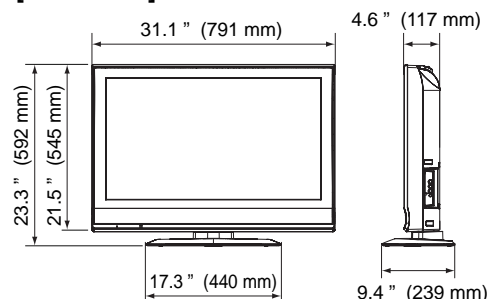

Note

● Design and Specifications are subject to change without notice. Mass and Dimensions shown are approximate.

Limited Warranty (for U.S.A.)

PANASONIC CONSUMER ELECTRONICS COMPANY,
DIVISION OF:
PANASONIC CORPORATION OF NORTH AMERICA
One Panasonic Way
Secaucus, New Jersey 07094

PANASONIC SALES COMPANY,
DIVISION OF:
PANASONIC PUERTO RICO, INC.
Ave. 65 de Infanteria, Km. 9.5
San Gabriel Industrial Park
Carolina, Puerto Rico 00985

Panasonic LCD Televisions Limited Warranty

Limited Warranty Coverage

If your product does not work properly because of a defect in materials or workmanship, Panasonic Consumer Electronics Company or Panasonic Puerto Rico, Inc. (collectively referred to as "the warrantor") will, for the length of the period indicated on the chart below, which starts with the date of original purchase ("warranty period"), at its option either (a) repair your product with new or refurbished parts, or (b) replace it with a new or a refurbished product. The decision to repair or replace will be made by the warrantor.

LCD TV CATEGORIES	PARTS	LABOR	SERVICE
Up to 20" (diagonal)	1 (ONE) YEAR	1 (ONE) YEAR	Carry-In or Mail-in
21" (diagonal) and larger			In Home or Carry-in / Mail in

During the "Labor" warranty period there will be no charge for labor. During the "Parts" warranty period, there will be no charge for parts. You must carry-in or mail-in your product during the warranty period. If non-rechargeable batteries are included, they are not warranted. This warranty only applies to products purchased and serviced in the United States or Puerto Rico. This warranty is extended only to the original purchaser of a new product which was not sold "as is". A purchase receipt or other proof of the original purchase date is required for warranty service.

In-Home or Carry-in Service

For In-Home or Carry-In Service in the United States call 1-800-211-PANA(7262) or visit the Panasonic web Site: <http://www.panasonic.com>.

For assistance in Puerto Rico call Panasonic Puerto Rico, Inc. (787)-750-4300 or fax (787)-768- 2910.

In-Home service requires clear, complete and easy access to the product by the authorized servicer and does not include removal or re-installation of an installed product. It is possible that certain in-home repairs will not be completed in-home, but will require that the product, or parts of the product, be removed for shop diagnosis and/or repair and then returned.

Limited Warranty Limits And Exclusions

This warranty ONLY COVERS failures due to defects in materials or workmanship, and DOES NOT COVER normal wear and tear or cosmetic damage, nor does it cover markings or retained images on the LCD panel resulting from viewing fixed images (including, among other things, letterbox pictures on standard 4:3 screen TV's, or non-expanded standard 4:3 pictures on wide screen TV's, or onscreen data in a stationary and fixed location). The warranty ALSO DOES NOT COVER damages which occurred in shipment, or failures which are caused by products not supplied by the warrantor, or failures which result from accidents, misuse, abuse, neglect, bug infestation, mishandling, misapplication, alteration, faulty installation, set-up adjustments, misadjustment of consumer controls, improper maintenance, power line surge, lightning damage, modification, or commercial use (such as in a hotel, office, restaurant, or other business), rental use of the product, service by anyone other than a Factory Service Center or other Authorized Servicer, or damage that is attributable to acts of God.

THERE ARE NO EXPRESS WARRANTIES EXCEPT AS LISTED UNDER "LIMITED WARRANTY COVERAGE". THE WARRANTOR IS NOT LIABLE FOR INCIDENTAL OR CONSEQUENTIAL DAMAGES RESULTING FROM THE USE OF THIS PRODUCT, OR ARISING OUT OF ANY BREACH OF THIS WARRANTY. (As examples, this excludes damages for lost time, cost of having someone remove or re-install an installed unit if applicable, or travel to and from the servicer. The items listed are not exclusive, but are for illustration only.) **ALL EXPRESS AND IMPLIED WARRANTIES, INCLUDING THE WARRANTY OF MERCHANTABILITY, ARE LIMITED TO THE PERIOD OF THE LIMITED WARRANTY.**

Some states do not allow the exclusion or limitation of incidental or consequential damages, or limitations on how long an implied warranty lasts, so the exclusions may not apply to you.

This warranty gives you specific legal rights and you may also have others rights which vary from state to state. If a problem with this product develops during or after the warranty period, you may contact your dealer or Service Center. If the problem is not handled to your satisfaction, then write to the warrantor's Consumer Affairs Department at the addresses listed for the warrantor.

PARTS AND SERVICE (INCLUDING COST OF AN IN-HOME SERVICE CALL, WHERE APPLICABLE) WHICH ARE NOT COVERED BY THIS LIMITED WARRANTY ARE YOUR RESPONSIBILITY.

Customer Services Directory (for U.S.A.)

Customer Services Directory

Obtain Product Information and Operating Assistance; locate your nearest Dealer or Service Center; purchase Parts and Accessories; or make Customer Service and Literature requests by visiting our Web Site at:

[**http://www.panasonic.com/consumersupport**](http://www.panasonic.com/consumersupport)

or, contact us via the web at:

[**http://www.panasonic.com/contactinfo**](http://www.panasonic.com/contactinfo)

You may also contact us directly at:

1-800-211-PANA (7262)

Monday-Friday 9 am-9 pm; Saturday-Sunday 10 am-7 pm, EST.

■ For hearing or speech impaired TTY users, TTY: 1-877-833-8855

Accessory Purchases

Purchase Parts, Accessories and Instruction Books on line for all Panasonic Products by visiting our Web Site at:

[**http://www.pstc.panasonic.com**](http://www.pstc.panasonic.com)

or, send your request by E-mail to:

[**npcparts@us.panasonic.com**](mailto:npcparts@us.panasonic.com)

You may also contact us directly at:

1-800-332-5368 (Phone) 1-800-237-9080 (Fax Only) (Monday - Friday 9 am to 8 pm, EST.)

Panasonic Services and Technology Company

20421 84th Avenue South,

Kent, WA 98032

(We Accept Visa, MasterCard, Discover Card, American Express, and Personal Checks)

■ For hearing or speech impaired TTY users, TTY: 1-866-605-1277

Service in Puerto Rico

Panasonic Puerto Rico, Inc.

Ave. 65 de Infantería, Km. 9.5, San Gabriel Industrial Park,

Carolina, Puerto Rico 00985

Phone (787)750-4300, Fax (787)768-2910

Limited Warranty (for Canada)

Panasonic Canada Inc.

PANASONIC PRODUCT - LIMITED WARRANTY

Panasonic Canada Inc. warrants this product to be free from defects in material and workmanship and agrees to remedy any such defect for a period as stated below from the date of original purchase.

Plasma TV / Monitor	In-home service	One (1) year, parts (including Plasma Panel) and labour.
LCD TV (26 in & over)	In-home service	One (1) year, parts (including LCD Panel) and labour.
LCD TV (25 in & under)	Carry-in service only	One (1) year, parts (including LCD Panel) and labour.

In-home Service will be carried out only to locations accessible by roads and within 50 km of an authorized Panasonic service facility.

LIMITATIONS AND EXCLUSIONS

This warranty does not apply to products purchased outside Canada or to any product which has been improperly installed, subjected to usage for which the product was not designed, misused or abused, damaged during shipping, or which has been altered or repaired in any way that affects the reliability or detracts from the performance, nor does it cover any product which is used commercially. Dry cell batteries are also excluded from coverage under this warranty.

This warranty is extended to the original end user purchaser only. A purchase receipt or other proof of date of original purchase is required before warranty service is performed.

THIS EXPRESS, LIMITED WARRANTY IS IN LIEU OF ALL OTHER WARRANTIES, EXPRESS OR IMPLIED, INCLUDING ANY IMPLIED WARRANTIES OF MERCHANTABILITY AND FITNESS FOR A PARTICULAR PURPOSE. IN NO EVENT WILL PANASONIC CANADA INC. BE LIABLE FOR ANY SPECIAL, INDIRECT OR CONSEQUENTIAL DAMAGES.

In certain instances, some jurisdictions do not allow the exclusion or limitation of incidental or consequential damages, or the exclusion of implied warranties, so the above limitations and exclusions may not be applicable.

In-home service requires clear, complete and easy access to the product by the Authorized Servicentre and does not include removal or re-installation of an installed product. If removal is required to service the product, it will be at the discretion of the Servicentre and in no event will Panasonic Canada Inc. or the Servicentre be liable for any special, indirect or consequential damages.

WARRANTY SERVICE

For product operation and information assistance, please contact:

Our Customer Care Centre: Telephone #: (905) 624-5505
1-800 #: 1-800-561-5505
Fax #: (905) 238-2360
Email link: "Customer support" on www.panasonic.ca

FOR PRODUCT REPAIRS, please locate your nearest Authorized Servicentre at www.panasonic.ca:

Link: "Servicentres™ locator" under "Customer support"

IF YOU SHIP THE PRODUCT TO A SERVICENTRE

Carefully pack and send prepaid, adequately insured and preferably in the original carton.
Include details of the defect claimed, and proof of date of original purchase.

Note



Customer's Record

The model number and serial number of this product can be found on its back cover. You should note this serial number in the space provided below and retain this book, plus your purchase receipt, as a permanent record of your purchase to aid in identification in the event of theft or loss, and for Warranty Service purposes.

Model Number _____

Serial Number _____

Anotación del cliente

El modelo y el número de serie de este producto se encuentran en su panel posterior. Deberá anotarlos en el espacio provisto a continuación y guardar este manual, más el recibo de su compra, como prueba permanente de su adquisición, para que le sirva de ayuda al identificarlo en el caso de que le sea sustraído o lo pierda, y también para disponer de los servicios que le ofrece la garantía.

Modelo _____

Número de serie _____

**Panasonic Consumer Electronics Company,
Division of Panasonic Corporation of North America**
One Panasonic Way, Secaucus
New Jersey 07094 U.S.A.

Panasonic Puerto Rico, Inc.
Ave. 65 de Infantería, Km. 9.5
San Gabriel Industrial Park
Carolina, Puerto Rico 00985

Panasonic Canada Inc.
5770 Ambler Drive
Mississauga, Ontario
L4W 2T3 CANADA